



JESUS
is
THE
GREATEST

MEDIA

LESSON 1





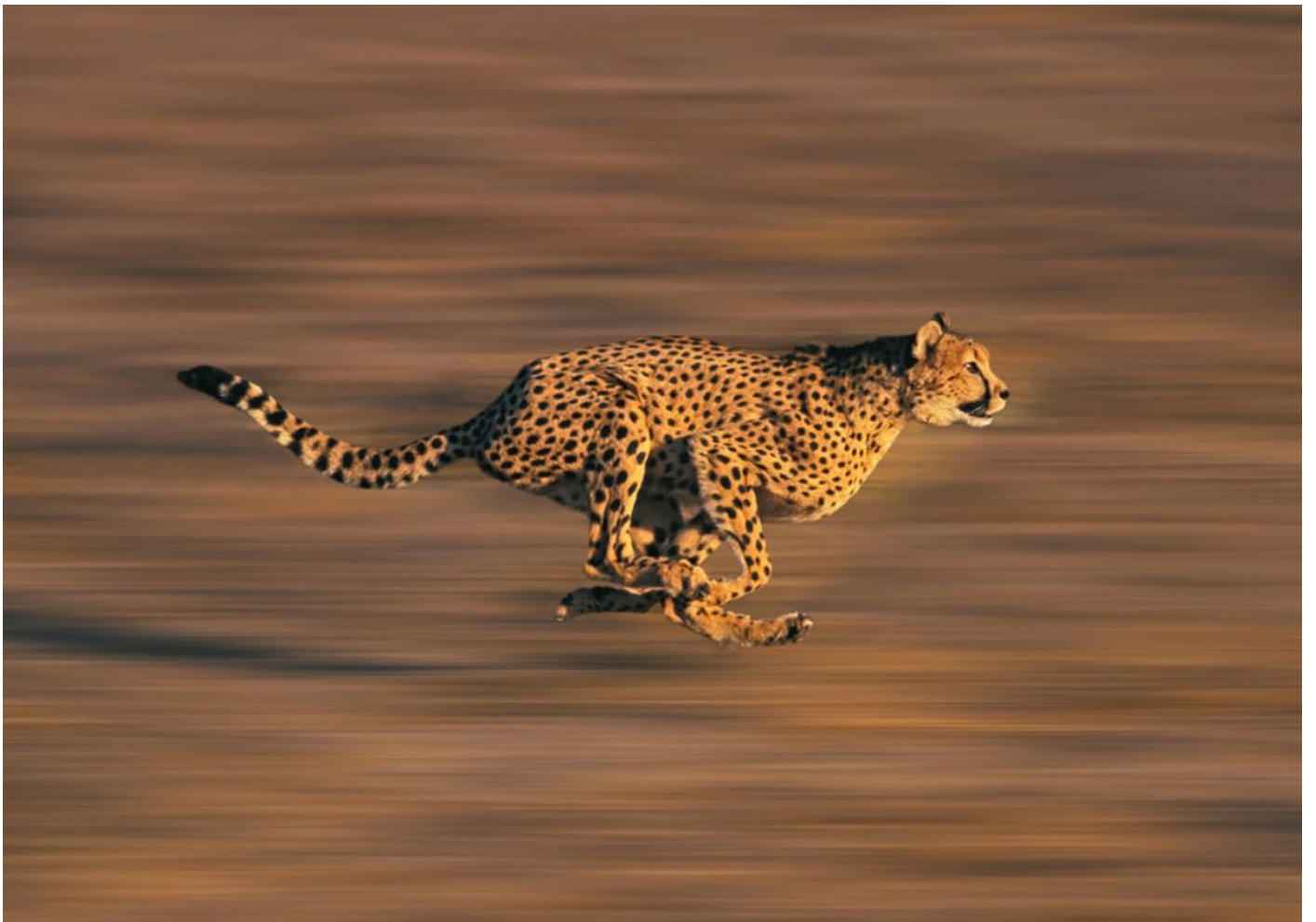

On day



God created light &
dark, day & night

Genesis 1:3-5

On day



God created the sky

Genesis 1:8

On day



God created plants &
trees

Genesis 1:11-12

On day



God created sun,
moon & stars

Genesis 1:16

On day

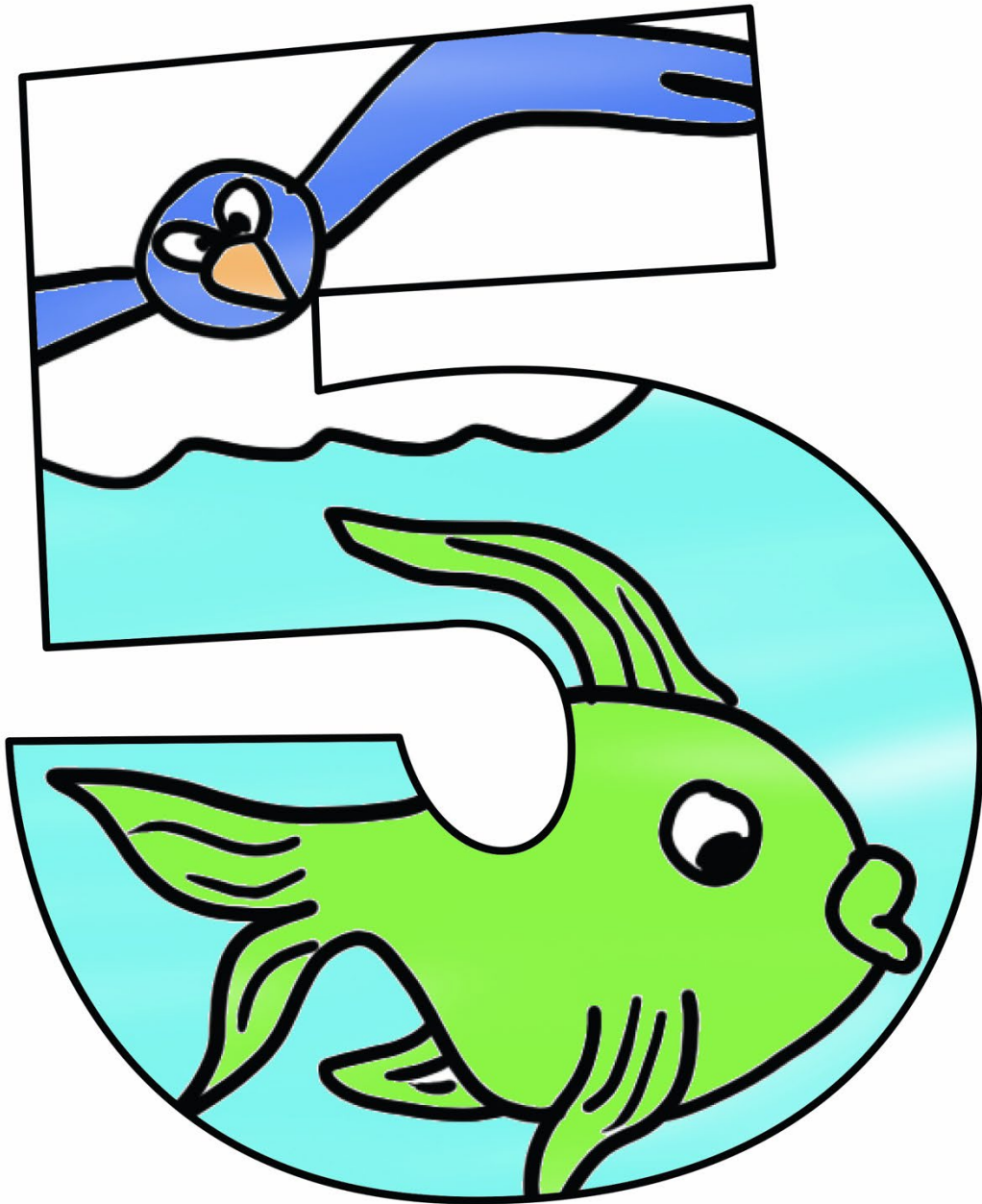

God created fish &
birds

Genesis 1:20

On day



God create animals &
people



Genesis 1:25 & 27

For through _____ God created everything in the heavenly realms and on earth. _____ made the things we can see and the things we can't see - such as thrones, kingdoms, rulers, and authorities in the unseen world. Everything was created through _____ and for _____ .

Colossians 1:16

Craft Option 1:

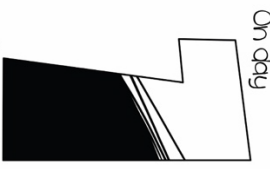
JESUS IS MY CREATOR



On day
God created light & dark, day & night
Genesis 1:3-5

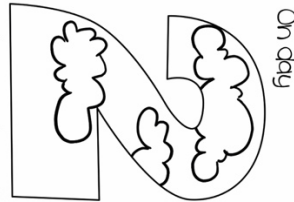

On day
God created the sky
Genesis 1:8



On day
God created plants & trees
Genesis 1:11-12



On day
God created sun, moon & stars
Genesis 1:16

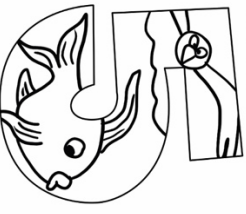

On day
God created fish & birds
Genesis 1:20



On day
God created animals & people
Genesis 1:25 & 27

Craft option 2:





Fold backwards and stick



Thank you Jesus for creating ...





Fold backwards and stick

Thank you Jesus for creating ...

<p>Ist Jesus existed before anything else was created</p> <p>Colossians 1:15</p>	<p>Everything was created through Jesus and 4 Jesus</p> <p>Colossians 1:16</p>	<p>Jesus holds ALL creation together</p>  <p>Colossians 1:17</p>	<p>Ist Jesus existed before anything else was created</p> <p>Colossians 1:15</p>	<p>Everything was created through Jesus and 4 Jesus</p> <p>Colossians 1:16</p>	<p>Jesus holds ALL creation together</p>  <p>Colossians 1:17</p>
--	--	---	--	--	---

<p>Ist Jesus existed before anything else was created</p> <p>Colossians 1:15</p>	<p>Everything was created through Jesus and 4 Jesus</p> <p>Colossians 1:16</p>	<p>Jesus holds ALL creation together</p>  <p>Colossians 1:17</p>	<p>Ist Jesus existed before anything else was created</p> <p>Colossians 1:15</p>	<p>Everything was created through Jesus and 4 Jesus</p> <p>Colossians 1:16</p>	<p>Jesus holds ALL creation together</p>  <p>Colossians 1:17</p>
--	--	---	--	--	---

<p>Ist Jesus existed before anything else was created</p> <p>Colossians 1:15</p>	<p>Everything was created through Jesus and 4 Jesus</p> <p>Colossians 1:16</p>	<p>Jesus holds ALL creation together</p>  <p>Colossians 1:17</p>	<p>Ist Jesus existed before anything else was created</p> <p>Colossians 1:15</p>	<p>Everything was created through Jesus and 4 Jesus</p> <p>Colossians 1:16</p>	<p>Jesus holds ALL creation together</p>  <p>Colossians 1:17</p>
--	--	---	--	--	---

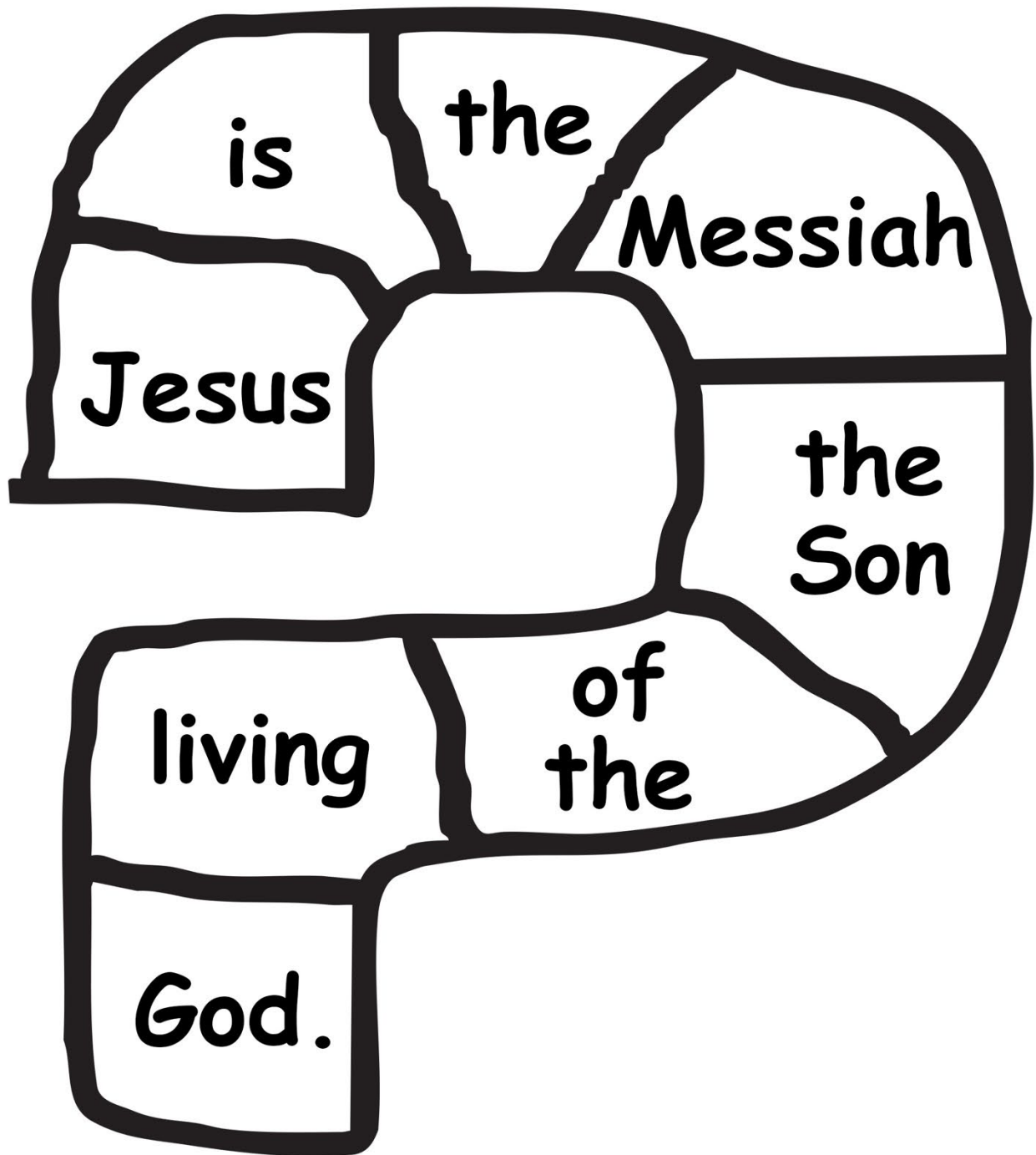

Matthew
16:16

<p>Jesus is the Messiah the Son of the living God.</p> <p>Matthew 16:16</p>	<p>Jesus is the Messiah the Son of the living God.</p> <p>Matthew 16:16</p>	<p>Jesus is the Messiah the Son of the living God.</p> <p>Matthew 16:16</p>	<p>Jesus is the Messiah the Son of the living God.</p> <p>Matthew 16:16</p>
<p>Jesus is the Messiah the Son of the living God.</p> <p>Matthew 16:16</p>	<p>Jesus is the Messiah the Son of the living God.</p> <p>Matthew 16:16</p>	<p>Jesus is the Messiah the Son of the living God.</p> <p>Matthew 16:16</p>	<p>Jesus is the Messiah the Son of the living God.</p> <p>Matthew 16:16</p>
<p>Jesus is the Messiah the Son of the living God.</p> <p>Matthew 16:16</p>	<p>Jesus is the Messiah the Son of the living God.</p> <p>Matthew 16:16</p>	<p>Jesus is the Messiah the Son of the living God.</p> <p>Matthew 16:16</p>	<p>Jesus is the Messiah the Son of the living God.</p> <p>Matthew 16:16</p>
<p>Jesus is the Messiah the Son of the living God.</p> <p>Matthew 16:16</p>	<p>Jesus is the Messiah the Son of the living God.</p> <p>Matthew 16:16</p>	<p>Jesus is the Messiah the Son of the living God.</p> <p>Matthew 16:16</p>	<p>Jesus is the Messiah the Son of the living God.</p> <p>Matthew 16:16</p>

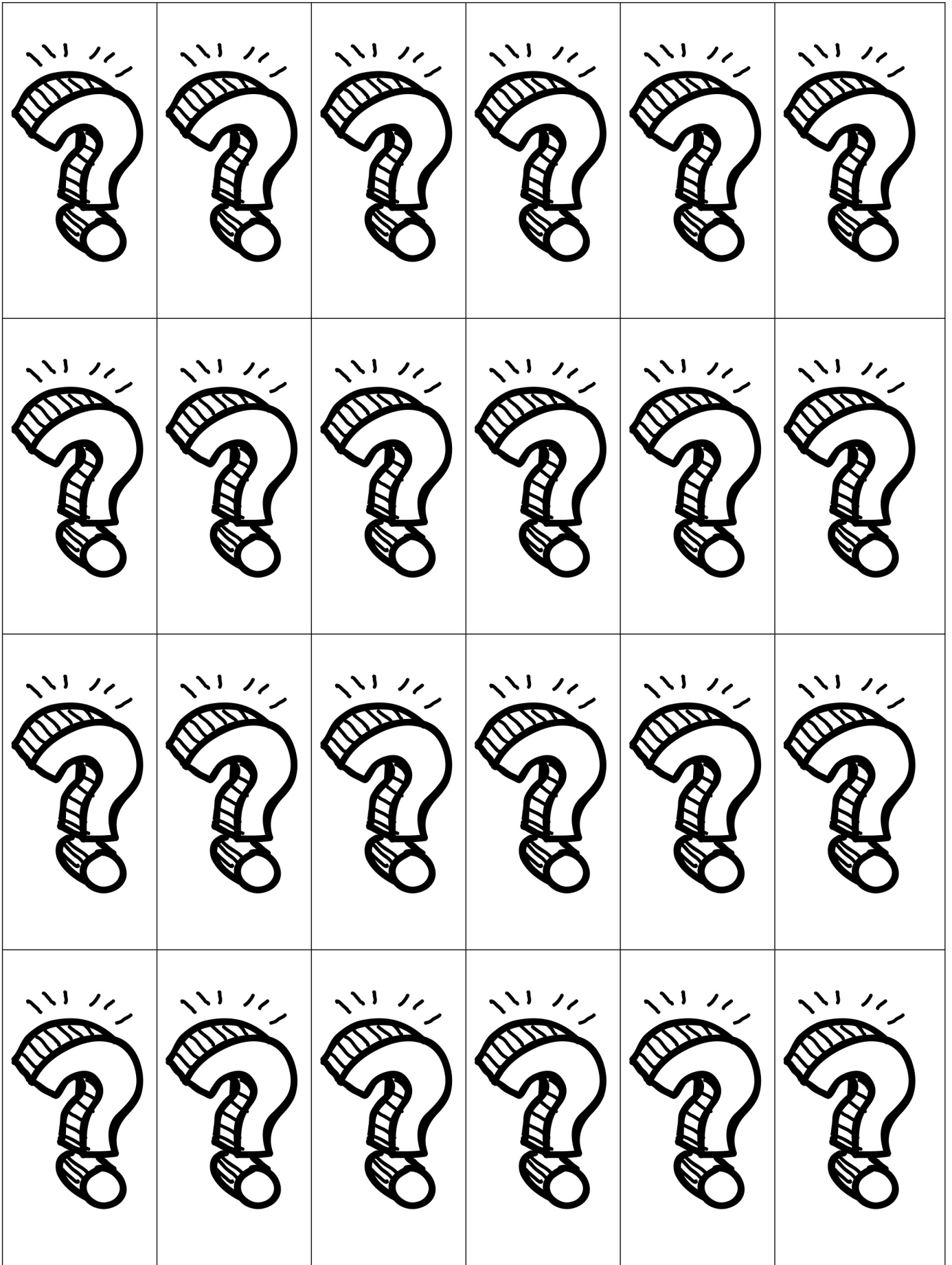

Born of a virgin (Isaiah 7:14)	Matthew 1:18-23	✓
Born in Bethlehem (Micah 5:2)	Matthew 2:1-6	✓
From the lineage of David (Jeremiah 23:5)	Luke 3:23-31	✓
Son of God (Psalm 2:7)	Matthew 3:17	✓
Called Immanuel, "God with us" (Isaiah 7:14)	Matthew 1:23	✓
Preceded by a messenger (Isaiah 40:3)	Matthew 3:1-3	✓
Ministry in Galilee (Isaiah 9:1-2)	Matthew 4:12-16	✓
Miracles: healing blind, deaf, lame (Isaiah 35:5-6)	Matthew 9:27-35, John 9:1-7	✓
Preached good news to the poor (Isaiah 61:1-2)	Luke 4:16-21	✓
Entered Jerusalem riding on a donkey (Zechariah 9:9)	Matthew 21:1-9	✓
Betrayed by a friend (Psalm 41:9)	John 13:18	✓
Sold for 30 pieces of silver (Zechariah 11:12-13)	Matthew 26:14-16	✓
Money thrown into the temple (Zechariah 11:13)	Matthew 27:5	✓
Silent before accusers (Isaiah 53:7)	Matthew 27:12-14	✓
Spat upon (Isaiah 50:6)	Matthew 26:67, 27:30	✓
Beaten (Isaiah 53:5)	Matthew 27:26	✓
Hands and feet pierced (Psalm 22:16)	Luke 23:33, John 20:25-27	✓
Crucified with criminals (Isaiah 53:12)	Luke 23:32-33	✓
Buried in a rich man's tomb (Isaiah 53:9)	Matthew 27:57-60	✓
No bones broken (Psalm 34:20)	John 19:33-36	✓
Forsaken by God (Psalm 22:1)	Matthew 27:46	✓
Mocked and insulted (Psalm 22:7-8)	Matthew 27:39-43	✓
Given vinegar to drink (Psalm 69:21)	Matthew 27:34	✓
Gall and vinegar offered (Psalm 69:21)	Matthew 27:34	✓
Burden of our sins (Isaiah 53:4-6)	2 Corinthians 5:21	✓
Pierced for our transgressions (Isaiah 53:5)	John 19:34	✓

Wounded for our iniquities (Isaiah 53:5)	1 Peter 2:24	✓
Silence before accusers (Isaiah 53:7)	Matthew 27:12-14	✓
Resurrection predicted (Psalm 16:10)	Acts 2:31	✓
Ascension to heaven (Psalm 68:18)	Acts 1:9	✓
Seated at God's right hand (Psalm 110:1)	Mark 16:19	✓
Out of Egypt (Hosea 11:1)	Matthew 2:14-15	✓
Flight to Egypt (Numbers 24:8)	Matthew 2:13-15	✓
Massacre of infants foretold (Jeremiah 31:15)	Matthew 2:16-18	✓
Ministry of miracles (Isaiah 35:5-6)	Matthew 11:4-6	✓
Teacher in parables (Psalm 78:2)	Matthew 13:34-35	✓
Rejected by His own people (Isaiah 53:3)	John 1:11	✓
Loved righteousness, hated wickedness (Psalm 45:7)	John 8:29	✓
He would be a priest forever (Psalm 110:4)	Hebrews 5:6	✓
Preceded by Elijah-like messenger (Malachi 4:5)	Matthew 3:1-3	✓
Called a Nazarene (Isaiah 11:1, Matthew 2:23)	Matthew 2:23	✓
Light to Gentiles (Isaiah 42:6)	Luke 2:32	✓
Rejected and despised (Isaiah 53:3)	John 1:11	✓
Silent before accusers (Isaiah 53:7)	Matthew 27:12-14	✓
Suffered and was crushed (Isaiah 53:5)	1 Peter 2:24	✓
Salvation offered to all nations (Isaiah 49:6)	Acts 13:47	✓
Spirit upon Him (Isaiah 61:1)	Luke 4:16-21	✓
Righteous sufferer (Isaiah 53)	1 Peter 2:21	✓
Preceded by messenger (Isaiah 40:3)	Matthew 3:1-3	✓
Everlasting kingdom (Daniel 7:14)	Luke 1:33	✓

**Who do
they say
I am?**

**Who do
you say
I am?**

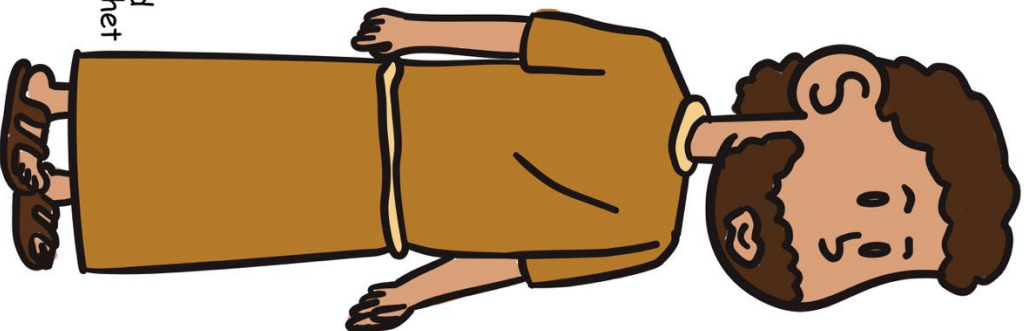

Who am I?

I was a prophet.

I was a man of God.
(1 King 17:24)

I passed on God's message.

Moses said God would raise up a great Prophet but that was not me.

I did not fulfil the prophecies about the Messiah.

I am ...

Elijah

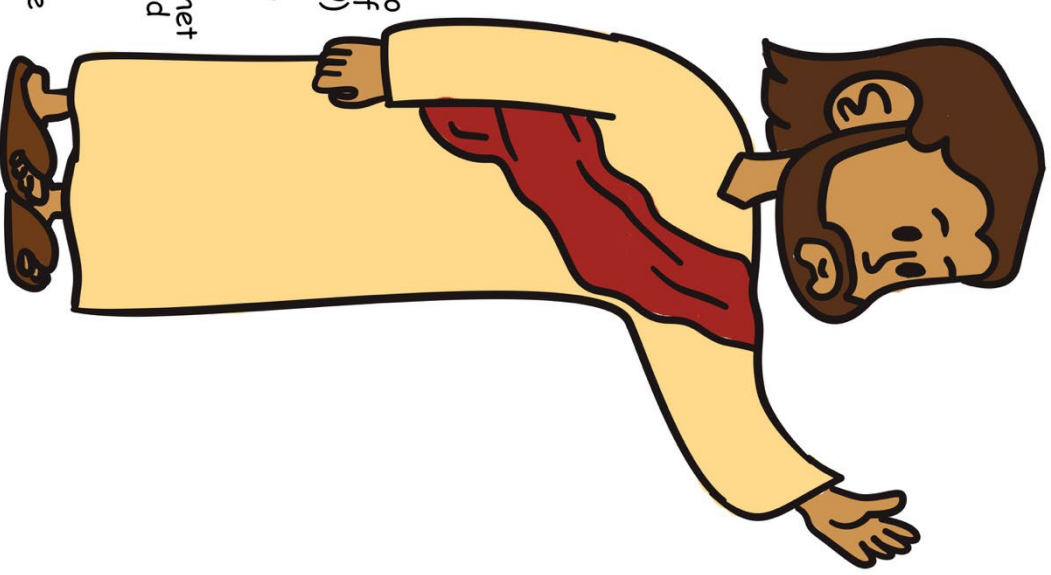

Who am I?

I am a prophet.

I am God's Son
(Matthew 3:17)

I am the Promised One, the Messiah.

I am the Saviour who takes away the sin of the world. (John 1:29)

I am the only way to God. (John 14:6)

I am the great prophet Moses said God would raise up.

I fulfilled all of the prophecies about the Messiah.
(2 Corinthians 1:20)

I am ...

Jesus

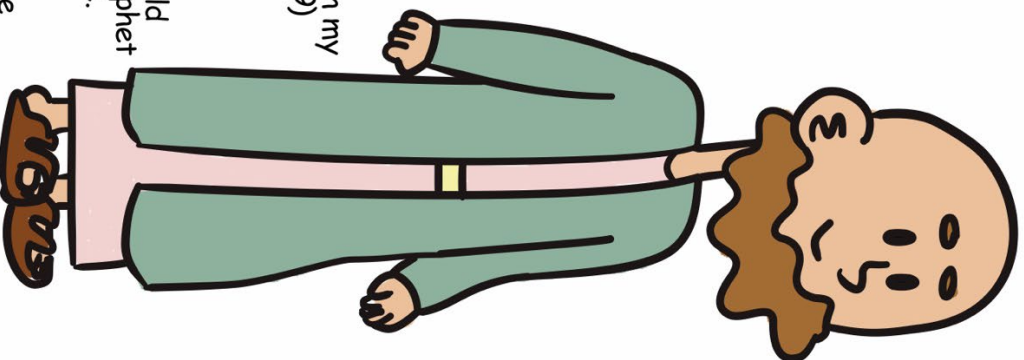

Who am I?

I was a prophet.

God put His words in my mouth. (Jeremiah 1:9)

I passed on God's message.

Moses said God would raise up a great Prophet but that was not me.

I did not fulfil the prophecies about the Messiah.

I am ...

Jeremiah

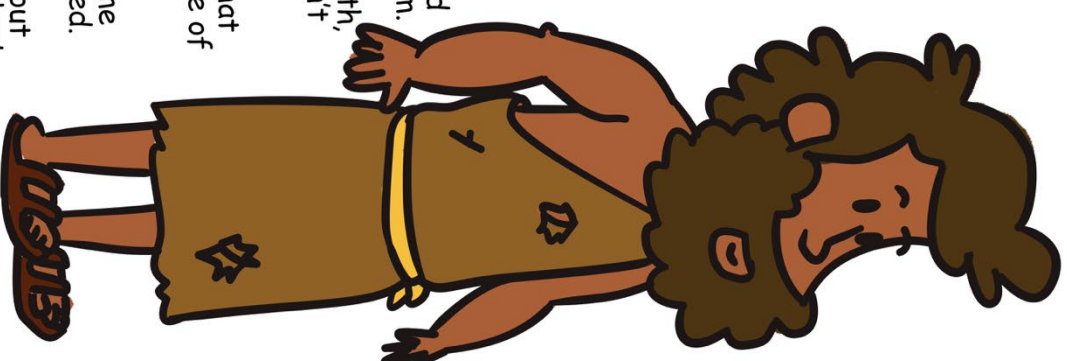

Who am I?

I was Jesus' cousin.

I told people about God and to turn back to Him.

I always spoke the truth, even when leaders didn't like it.

I kept telling others that Jesus is the chosen one of God. (John 1:34)

Herod got angry, had me arrested, and later killed.

When Herod heard about Jesus, he was afraid I had come back from the dead. (Mark 6:16)

I am ...

John

Craft option 1:

Who is Jesus to me?

Stick the memory verse into the puzzle
and fill the page with who Jesus is to you.

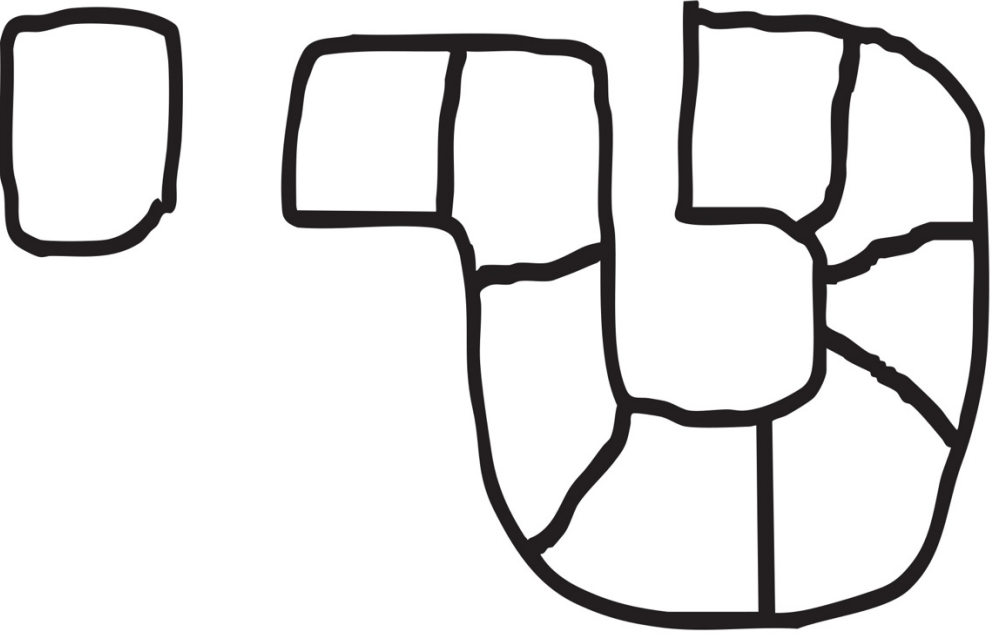

Cut and paste the verse onto the activity page.

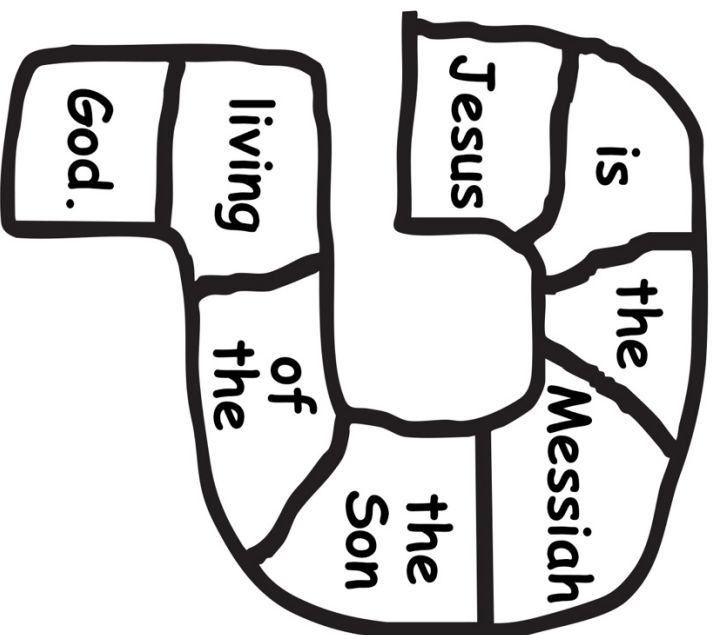

Craft option 2:

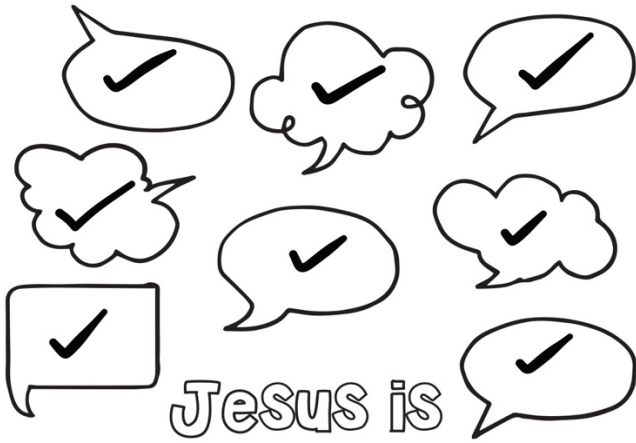

<p>The Promised One would be born in Bethlehem (Micah 5:2)</p>	<p>Jesus was born in Bethlehem (Matthew 2:1)</p>
<p>The Promised One would save us from sin (Isaiah 35:4)</p> <p>SAVE US FROM SIN</p>	<p>Jesus saves us from sin (Acts 4:12)</p> <p>SAVE US FROM SIN</p>
<p>The Promised One would be worshipped with gifts of frankincense and gold (Isaiah 60:6)</p>	<p>Jesus was worshipped with gifts of frankincense and gold (Matthew 2:11)</p>
<p>The Promised One would preach the Good News to the poor. (Isaiah 61:1-3)</p>	<p>Jesus preached the Good News to the poor (Luke 4:18-19)</p>

GLUE HERE

<p>The Promised One would teach in parables (Psalm 78:2)</p>	<p>Jesus taught in parables. (Matthew 13:34-35)</p>
<p>The Promised One would be killed and come alive again after three days (Matthew 12:40)</p>	<p>Jesus died and came alive after three days (Luke 24:6)</p>
<p>The Promised One would make the blind see and heal the sick. (Isaiah 35:5-6)</p>	<p>Jesus made the blind see and healed the sick. (Matthew 8:16; John 9:6-7)</p>
<p>The Promised One would ride a donkey as people praised Him (Zechariah 9:9)</p>	<p>Jesus rode a donkey as people praised Him (Matthew 21:7-9)</p>



Craft option 3:



John



Jeremiah

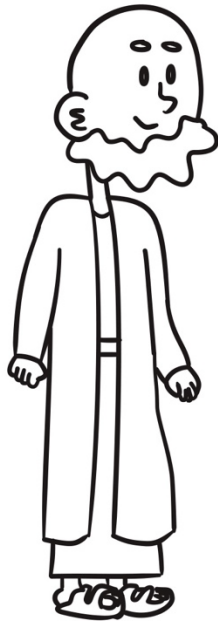

Elijah

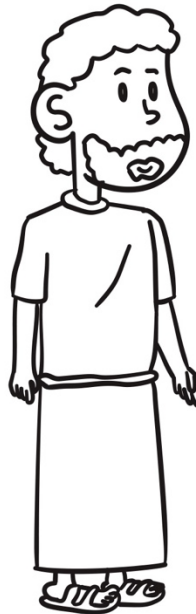

Jesus



Cut out the speech bubbles and use your Bible to match them to the correct person.

I am a prophet.
I pass on God's message.
1 Kings 17:24
Jeremiah 1:9

God put
His words
in my
mouth.
Jeremiah 1:9

I am
the Messiah,
the Son of
the living
God.
Matthew
16:1

Jesus is
the chosen
one of God.
John 1:34

I am a
man of
God.
1 Kings
17:24

I met all
of the
prophesies
2 Corinthians
1:20

He who is
coming is
mightier
than I.
Matthew 3:11

Promises Promises Promises

The Bible is filled with promises about Jesus.

What, where, when, how
and HE KEPT EVERY SINGLE ONE!

P	R	O	M	I	S	E	S	P	R	E	O	S	I	P
S	M	E	S	R	O	S	P	S	O	S	R	E	S	R
E	I	S	P	P	M	I	E	M	R	O	M	I	E	O
S	E	R	O	R	S	S	M	S	P	S	E	S	S	M
I	S	P	M	O	I	O	I	R	I	S	E	E	I	I
M	S	E	I	M	O	M	S	P	O	M	S	I	M	S
O	R	P	O	I	R	I	P	I	R	I	O	M	O	E
R	O	R	M	S	P	S	E	S	M	E	S	R	R	S
P	P	O	S	E	S	I	M	O	R	P	O	M	P	S
I	E	M	I	S	E	E	R	S	I	E	R	M	I	E
M	R	I	S	P	S	P	R	O	M	I	S	E	S	S
O	P	S	O	R	I	S	E	S	O	S	R	O	I	R
S	S	E	S	I	M	O	R	P	R	E	S	P	O	M
E	I	S	P	R	O	I	P	R	O	M	I	S	E	S
P	R	O	M	I	S	E	S	M	S	E	S	R	P	O

How many promises can you find? _____

And a voice from heaven
said, "_____ is _____
dearly _____,
who _____ Me great
_____." Matthew 3:17

This	My	beloved	Son
------	----	---------	-----

brings	joy
--------	-----



There was a young lady named **Mary** who
was promised to marry Joseph.

Joseph was a local **carpenter**.

One day an angel appeared to Mary and said
she would have a baby from the Holy Spirit.
The child would be the Son of God. Joseph
was worried when he found out Mary was
pregnant, but in a dream an **angel** told him,
"Don't be afraid, Joseph. The baby is from
the Holy Spirit!" Joseph trusted God and
stayed with Mary.



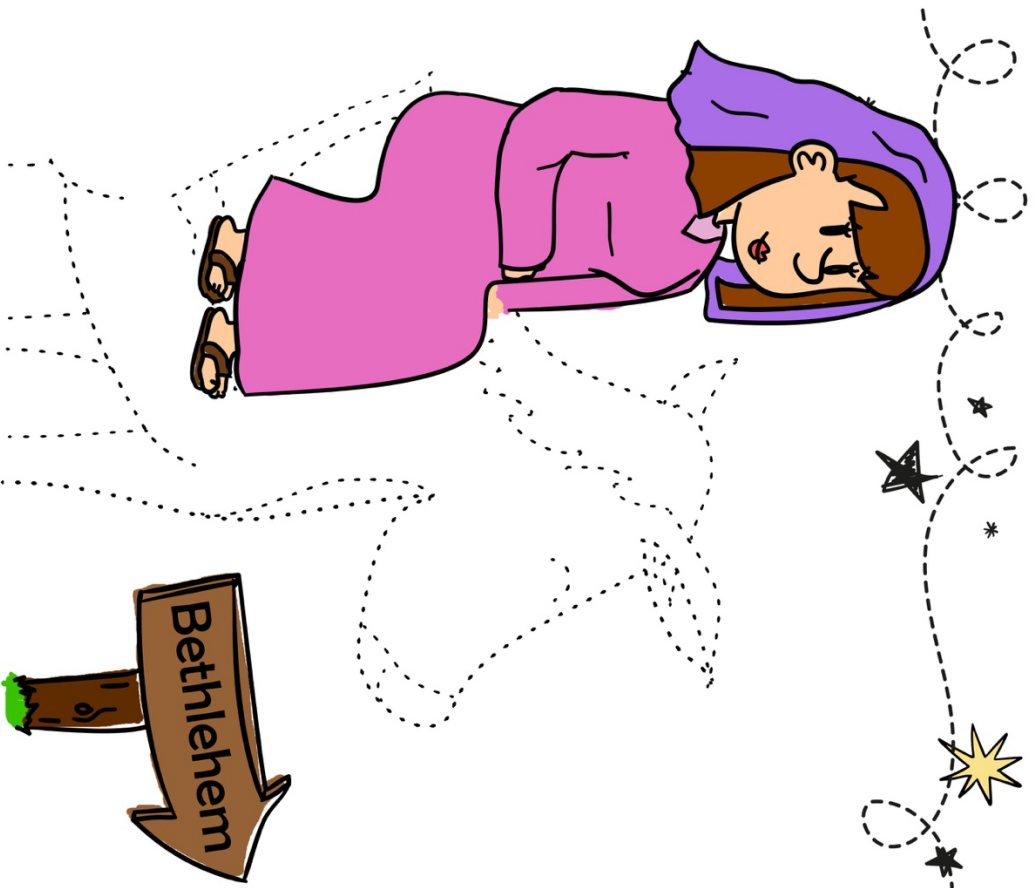

The ruler of the empire said everyone must be registered in their hometown, so Joseph and Mary travelled to Bethlehem. Mary was very pregnant and made the long journey,

maybe on a donkey.

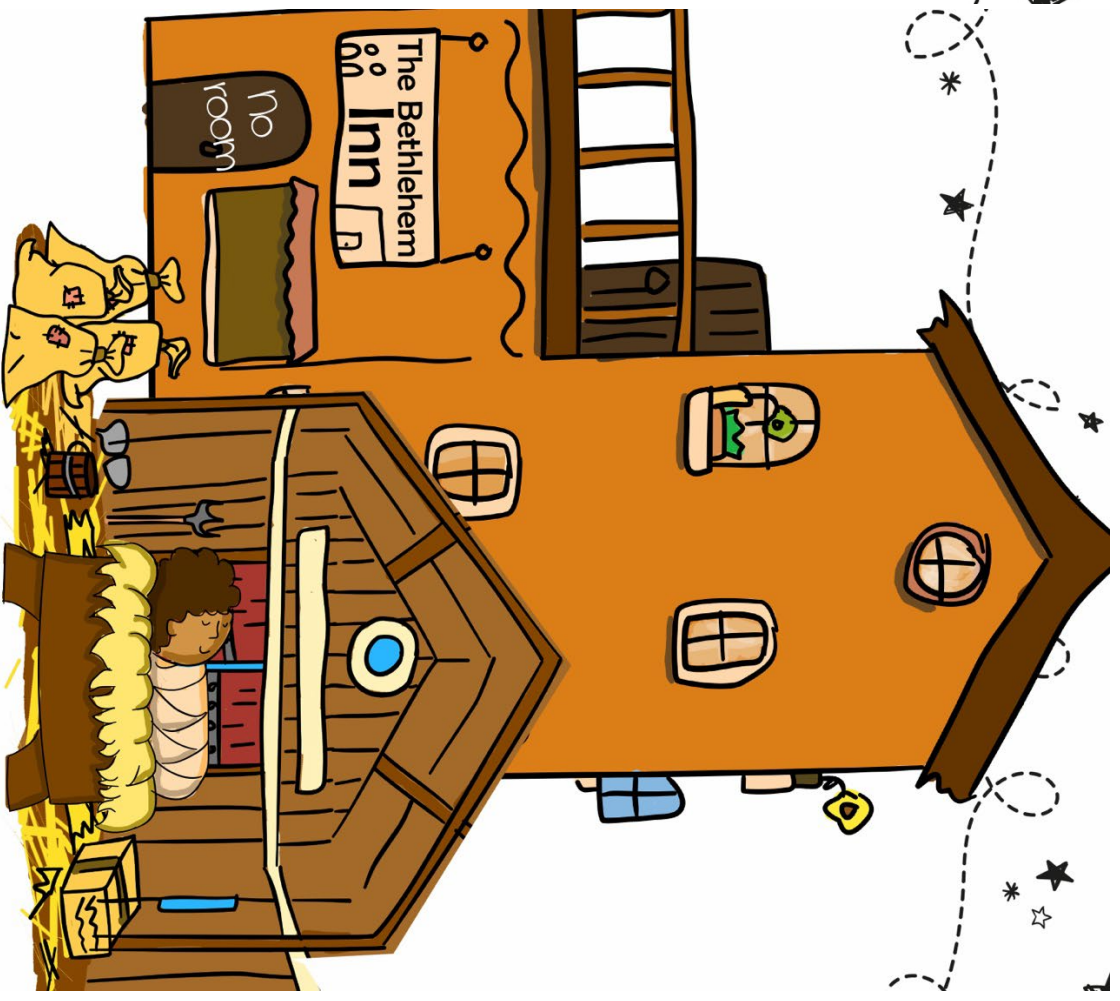

When they arrived, there was no room in any inn. Mary found a **stable** and gave birth to her son. She wrapped Him in cloth and laid Him in a **manger**.

GLORY TO GOD IN THE HIGHEST

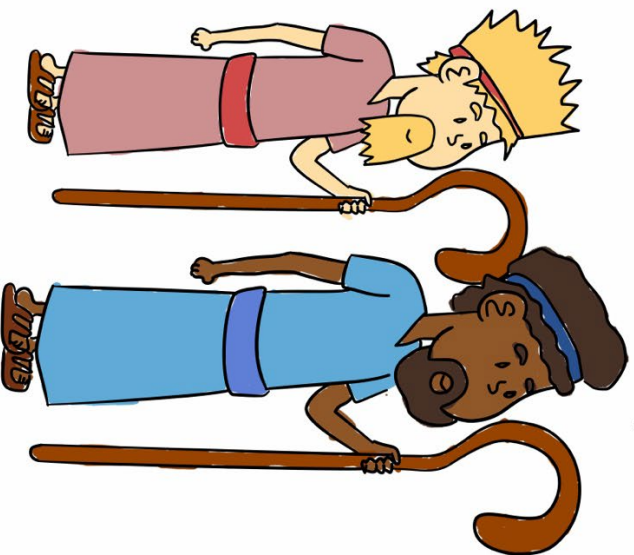
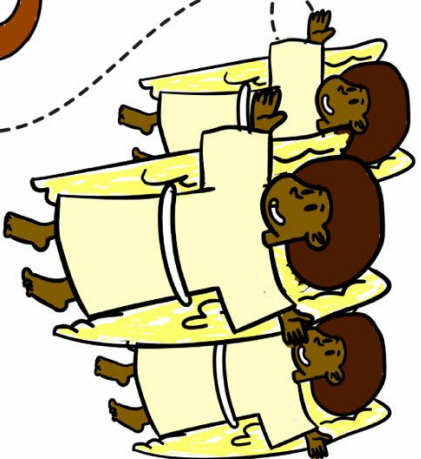

Nearby, **shepherds** were watching their sheep. Suddenly an angel appeared and said, "I bring you good news! Tonight a Saviour is born - the Messiah, the Lord. You will find Him lying in a manger." Then many angels praised God, singing, "Gloria to God in the highest..."

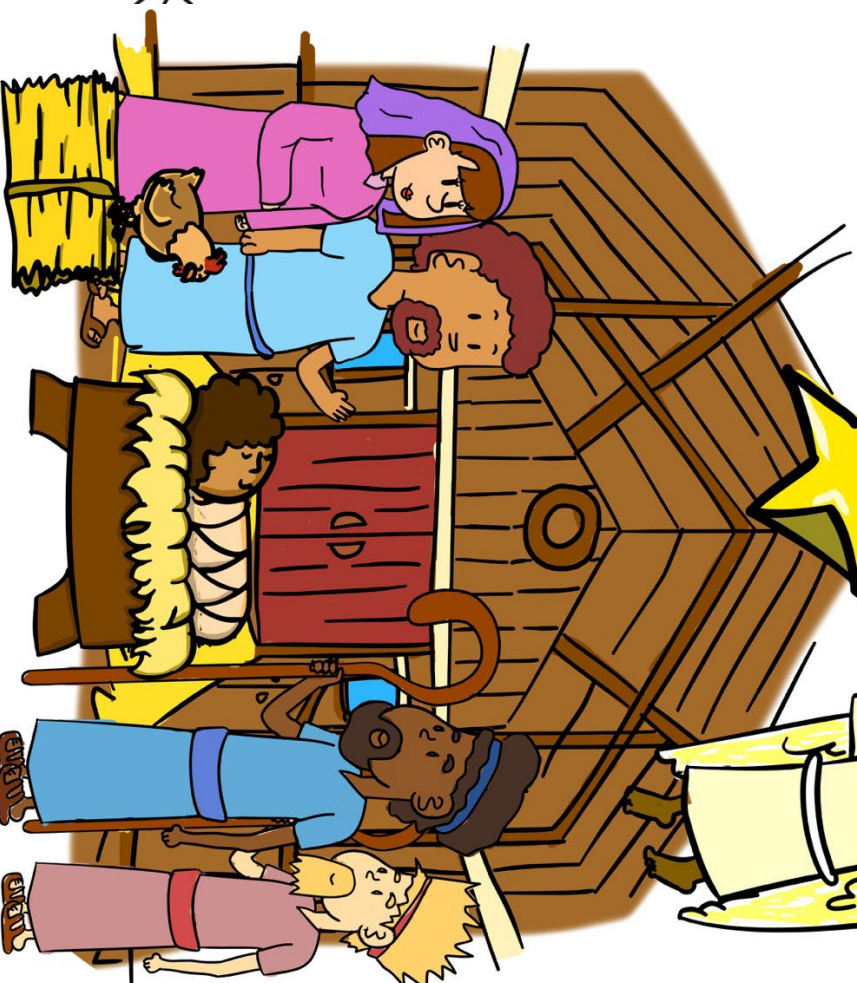

The shepherds hurried to Bethlehem and found Mary, Joseph, and the baby who was lying in a manger.



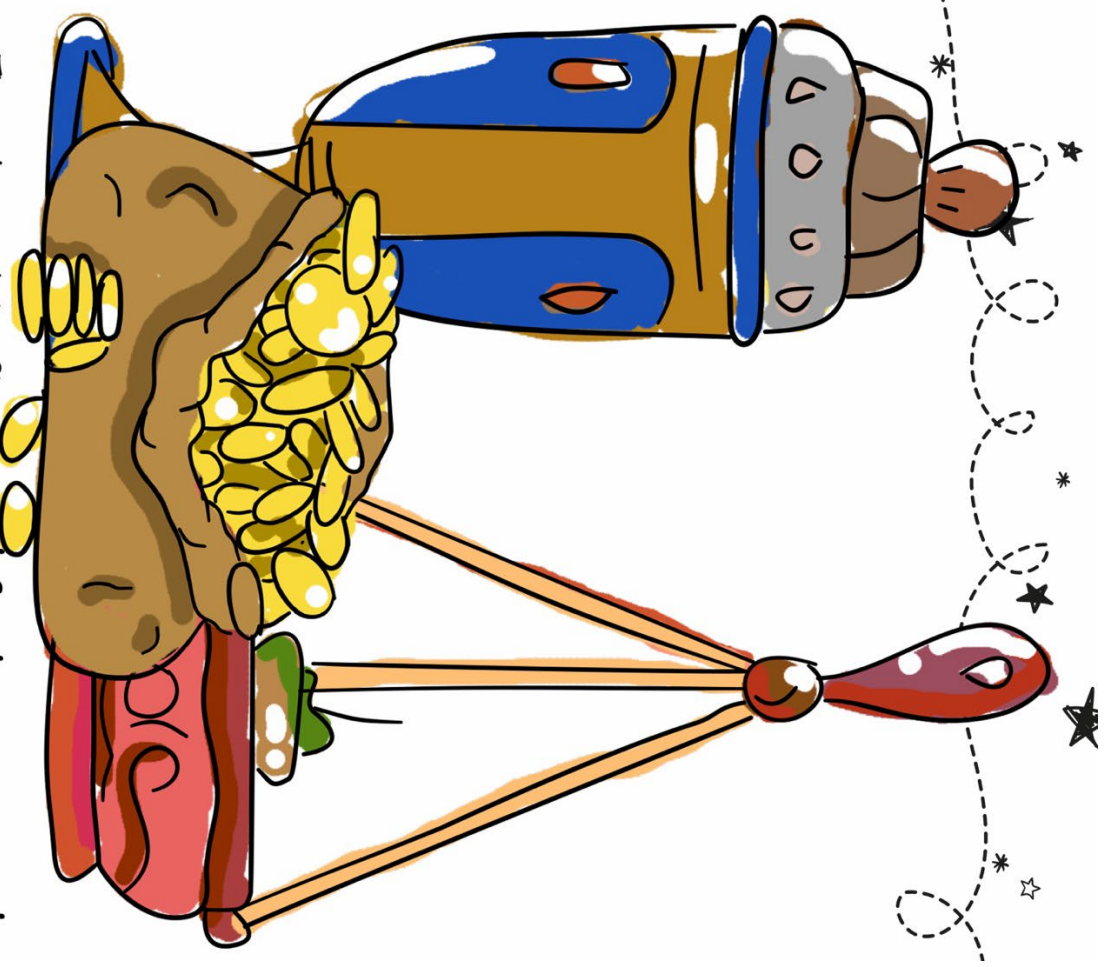
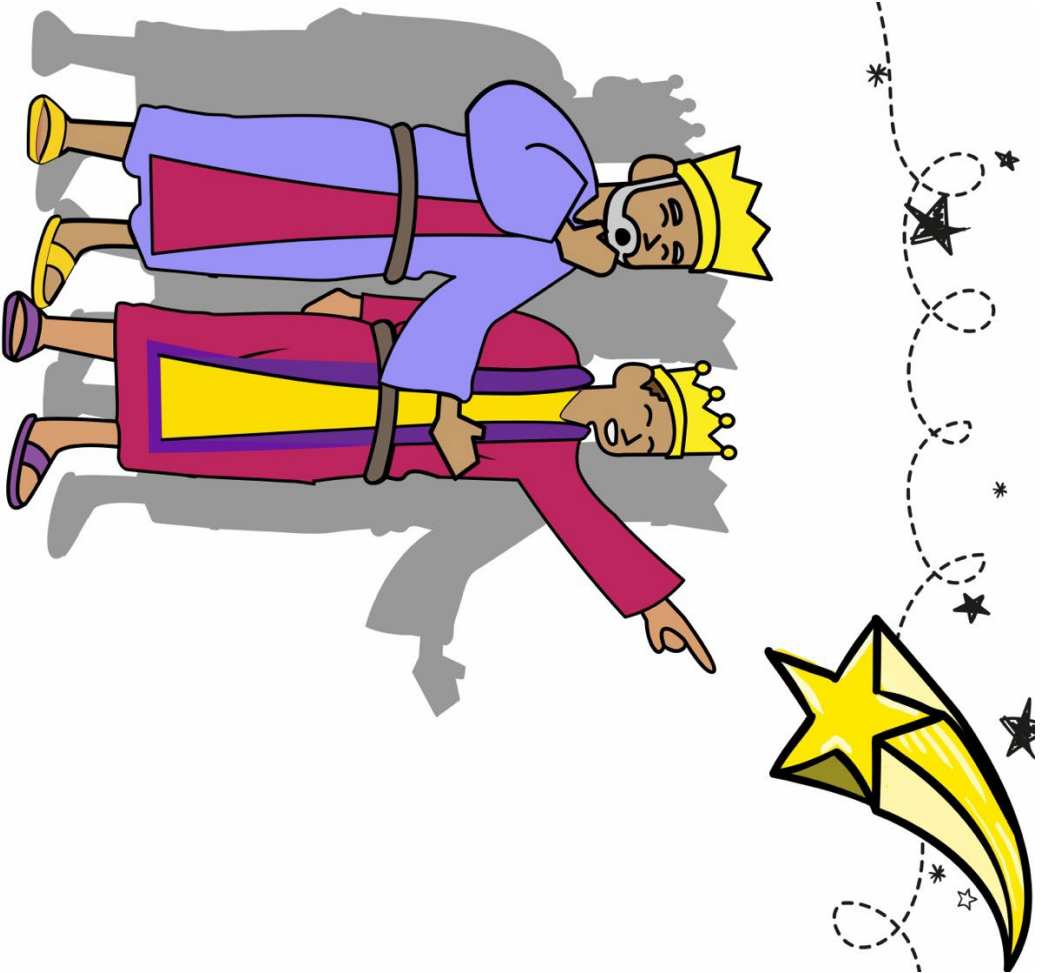

About two years later, wise men came from the East. They had seen a star

showing that a king was born.

They brought gifts of gold, frankincense, and myrrh and bowed down to worship Him.

On the eighth day the baby was named Jesus - the Son of God and Saviour of the world.

Craft option 1:

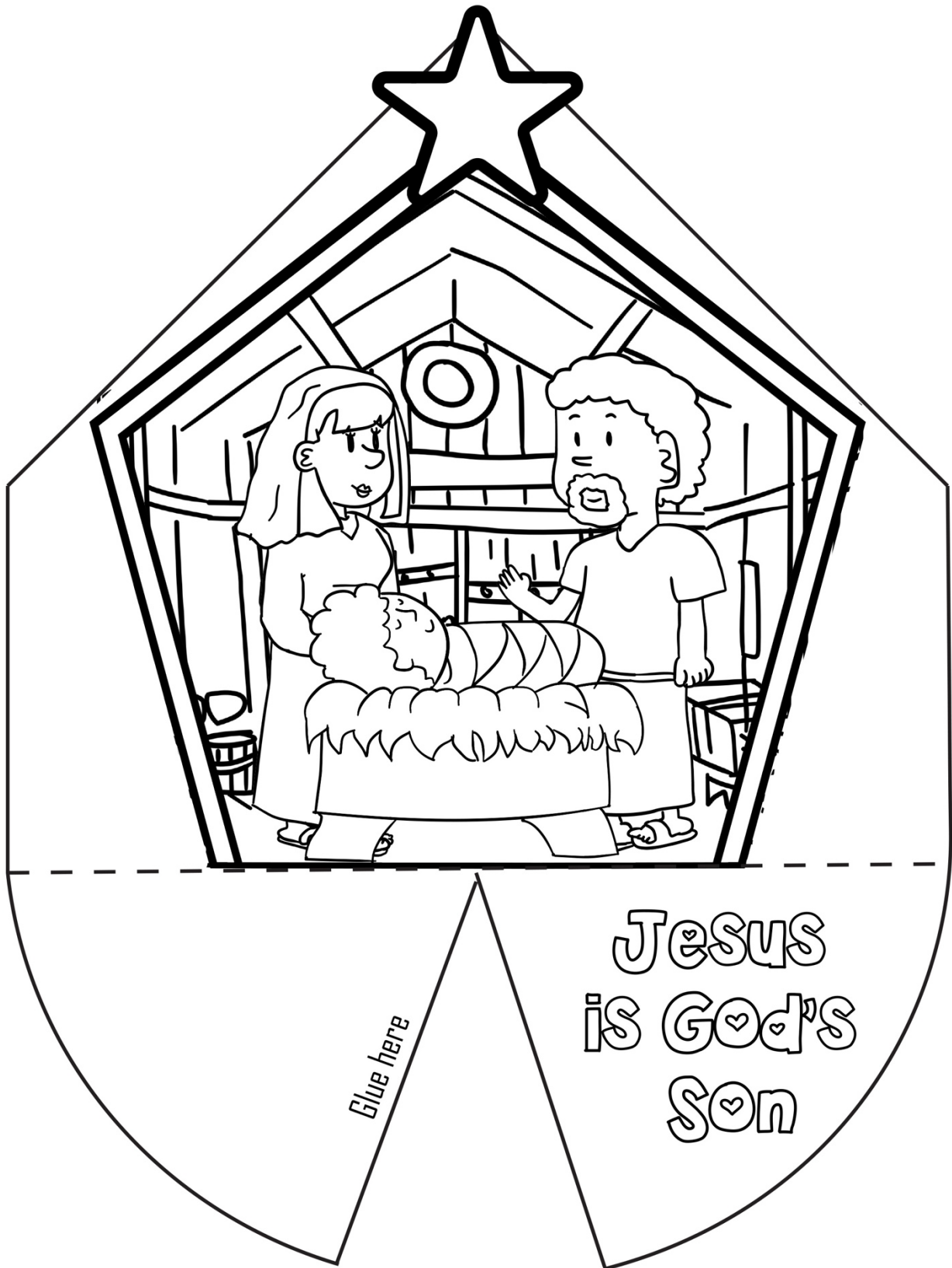

Who said it?

Look up the Bible verse and write who said it in the space provided.

"The baby to be born will be holy, and He will be called the **Son of God.**"
Luke 1:35

Teacher,
You are the **Son of God** -
the King of Israel!"
John 1:49

"I have always believed You are the Messiah, **the Son of God**, the one who has come into the world from God."
John 11:27

I saw this happen to Jesus, so I testify that He is the **Chosen One of God.**
John 1:34

"You are **My dearly loved Son**, and you bring Me great joy."
Luke 3:22

"This man truly was the **Son of God!**"
Matthew 27:54

JESUS IS
GOD'S SON

GOD'S
MESSAGE

GOD'S
MESSAGE

GOD'S
MESSAGE

GOD'S
MESSAGE

GOD'S
MESSAGE

GOD'S
MESSAGE

GOD'S
MESSAGE

GOD'S
MESSAGE



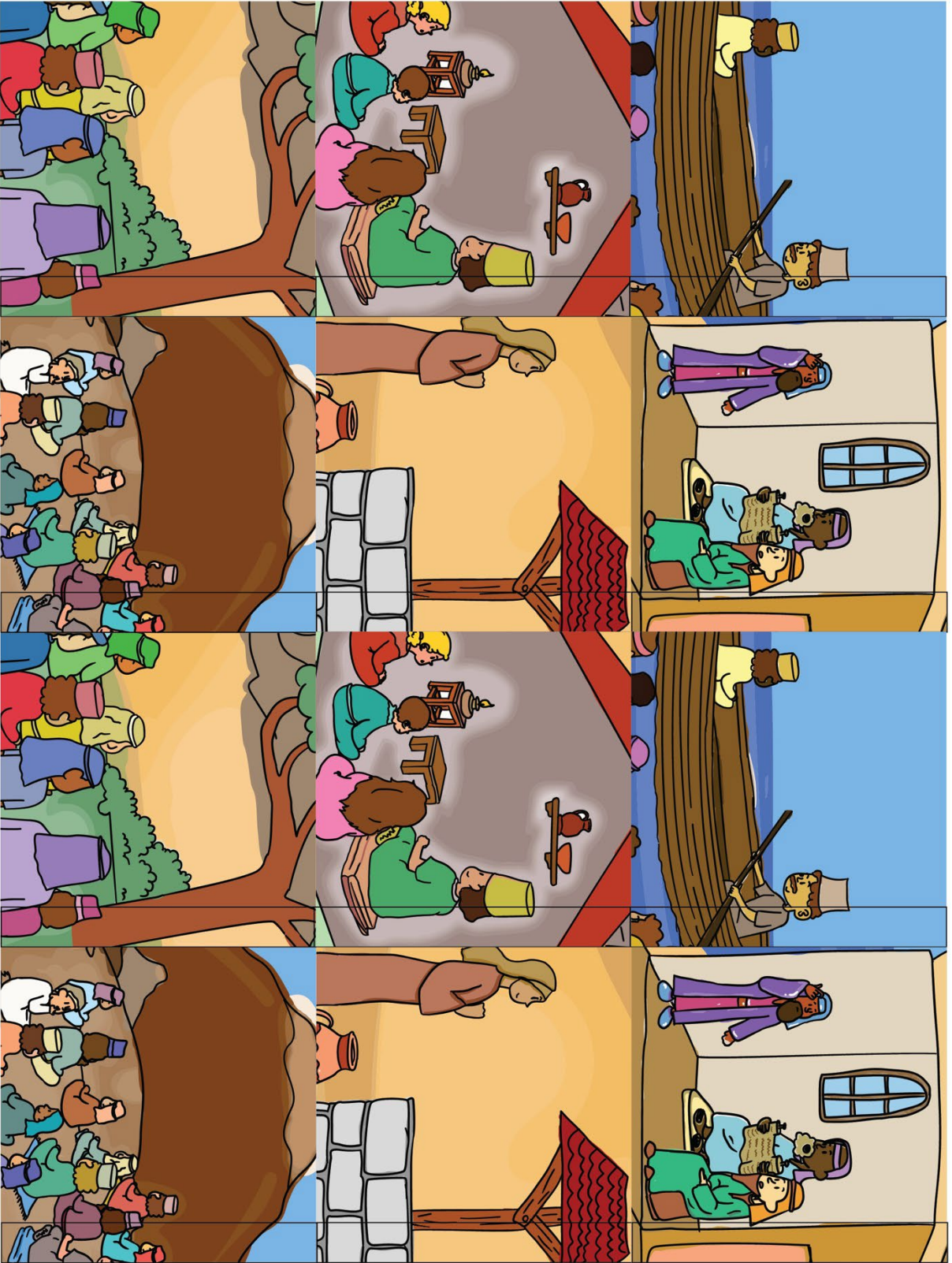

Craft option 1:

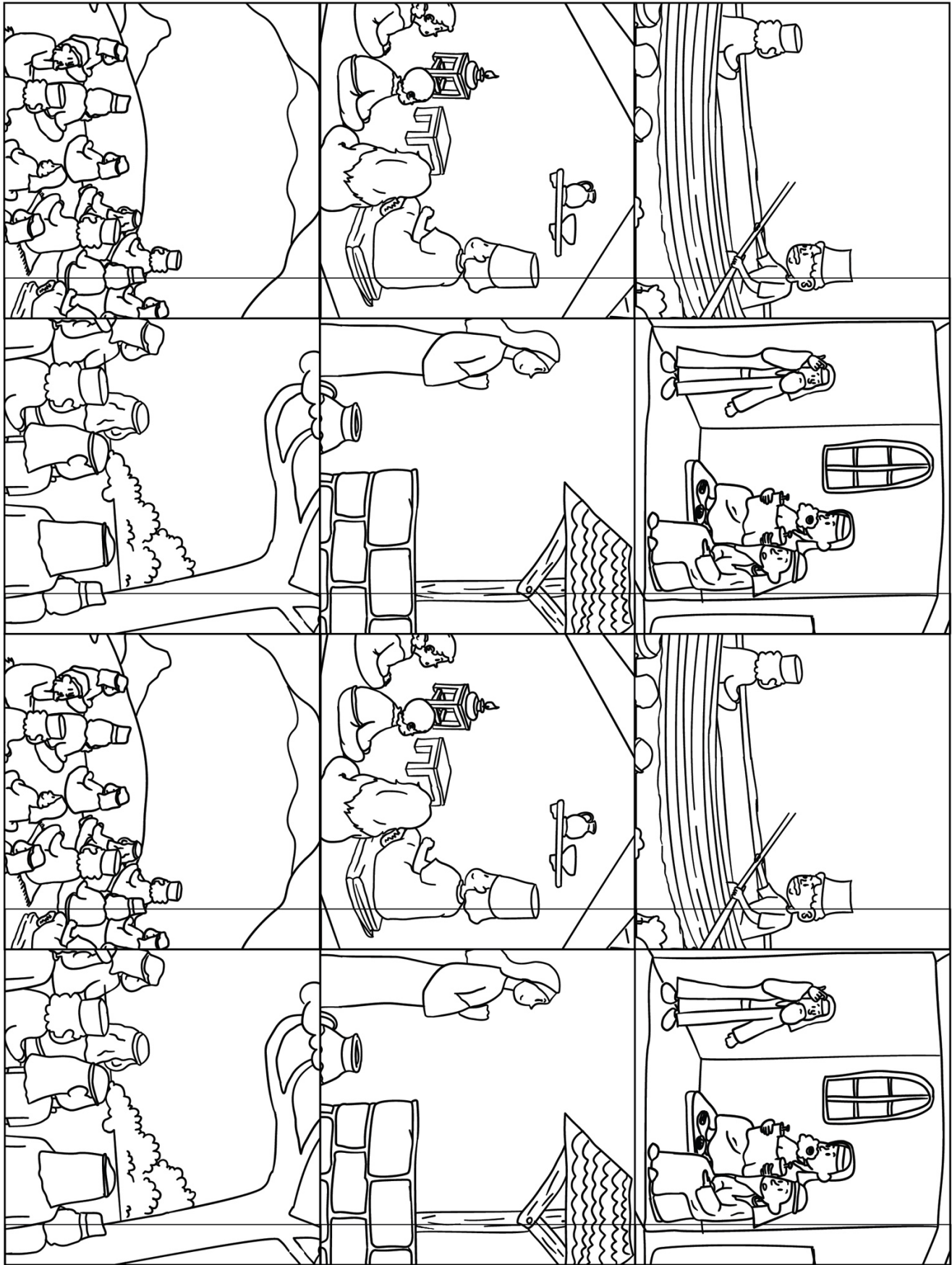

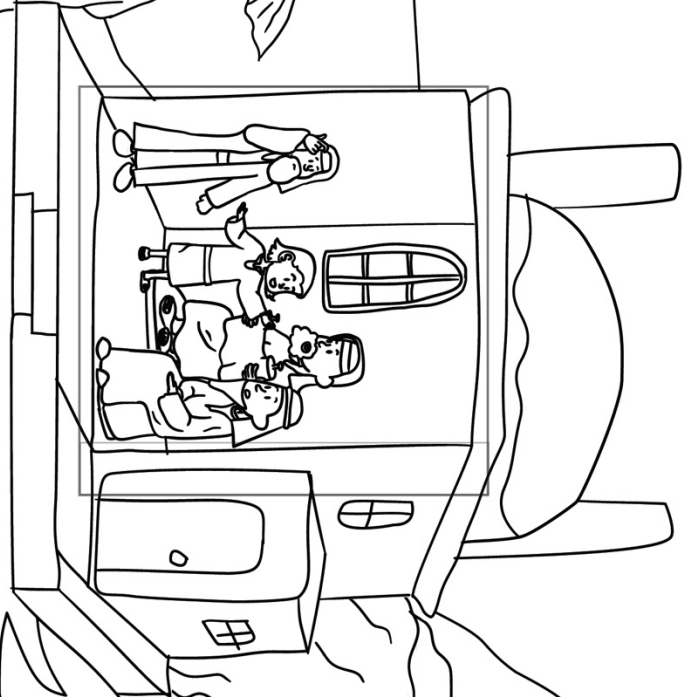
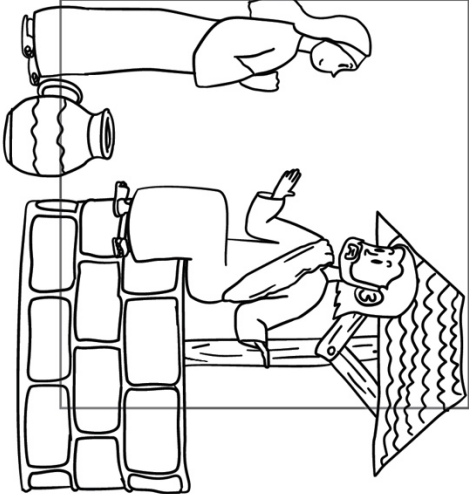
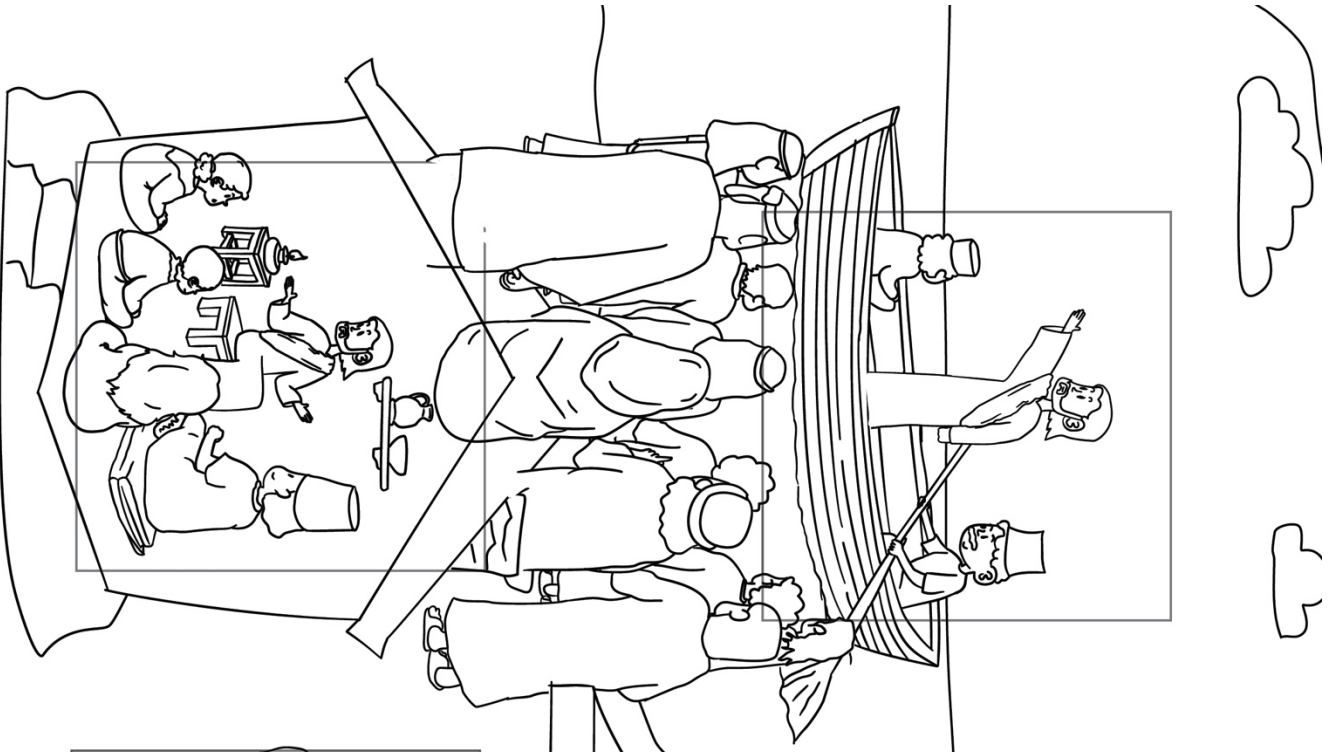

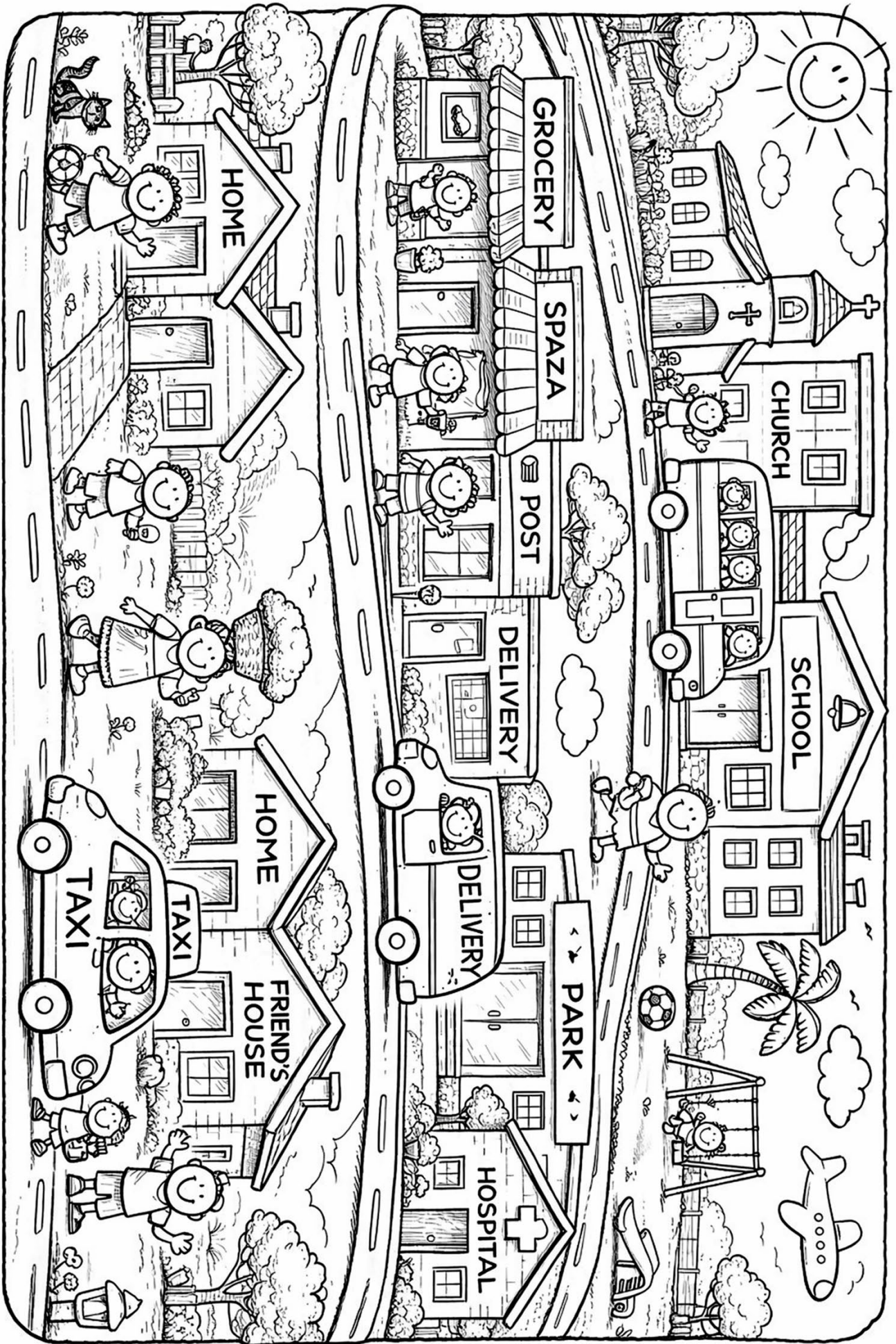

Craft option 3:

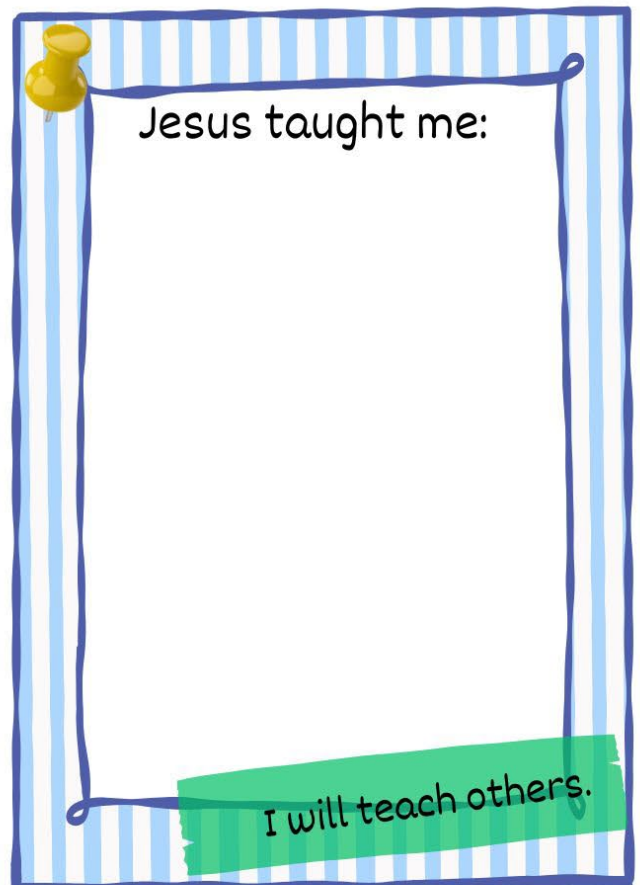
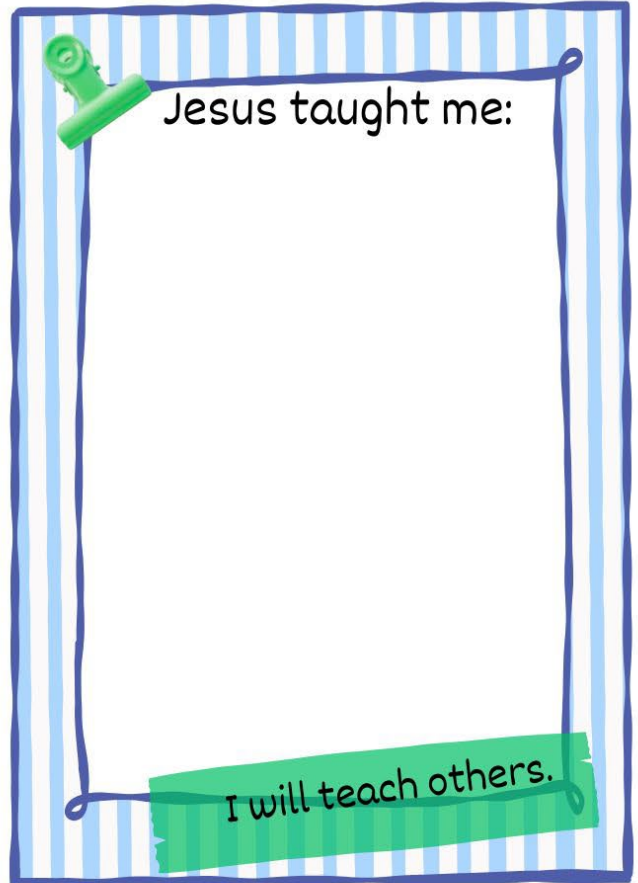

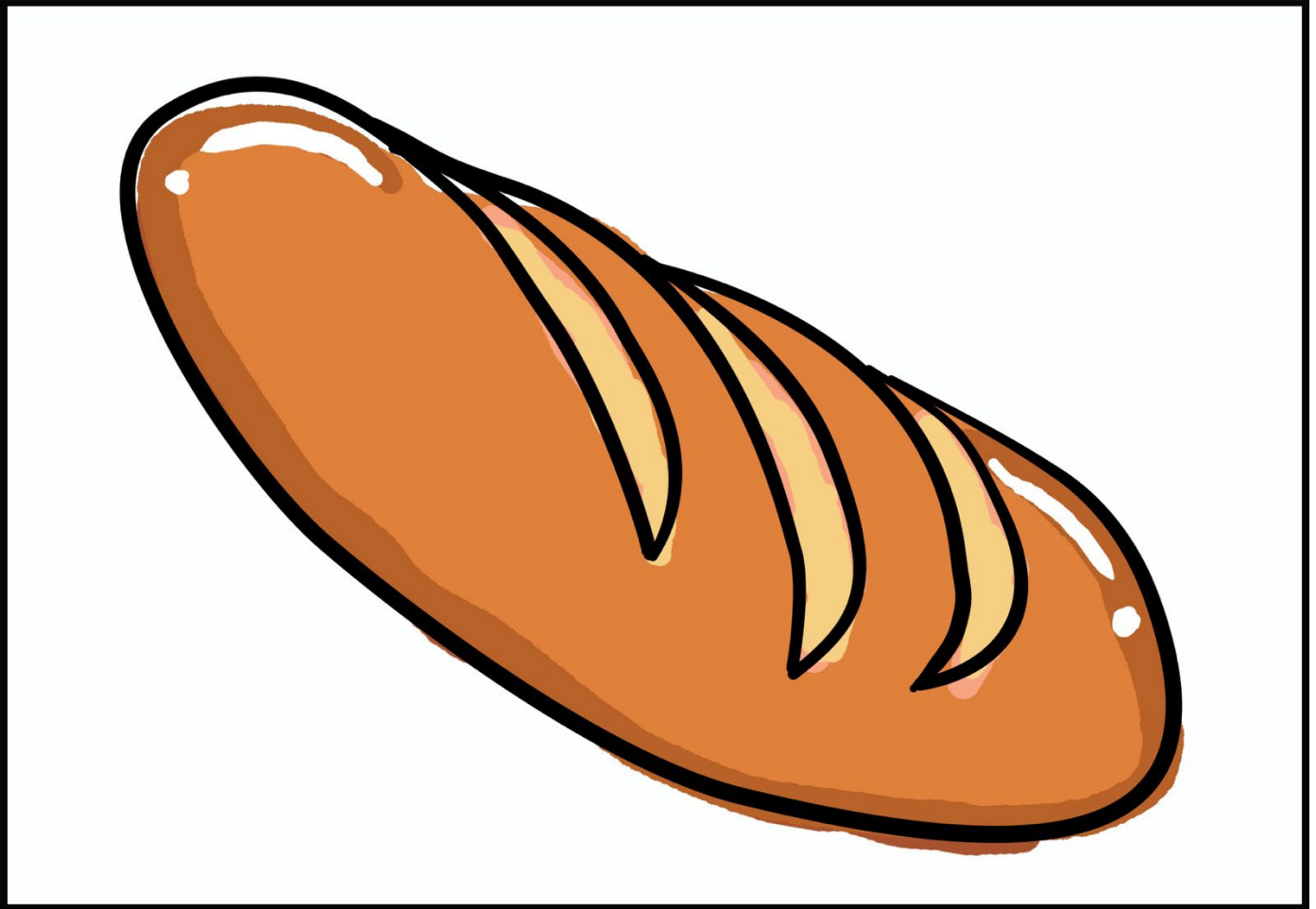

Jesus said
I AM

**The Breadd
of life**

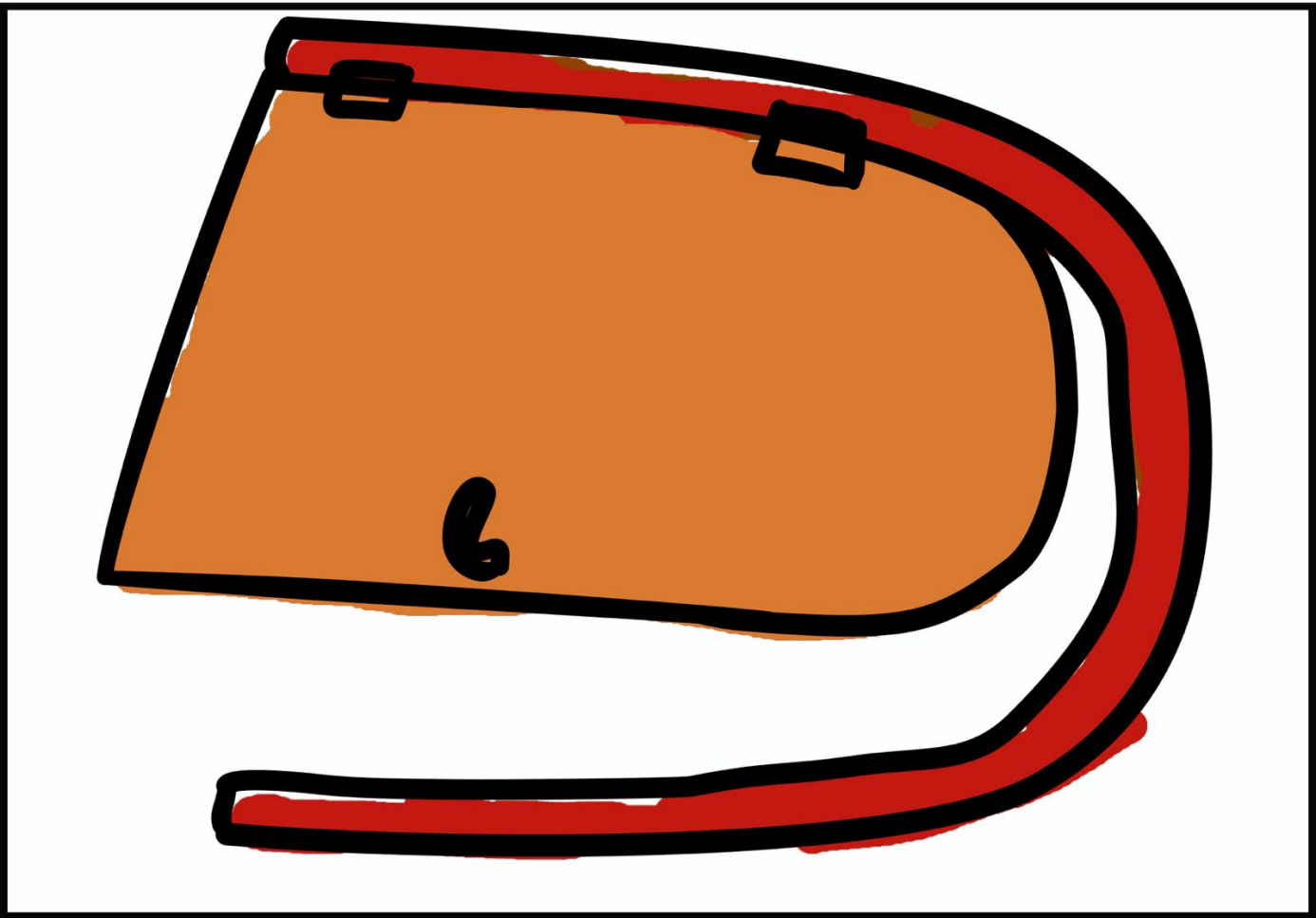

Jesus said

I AM

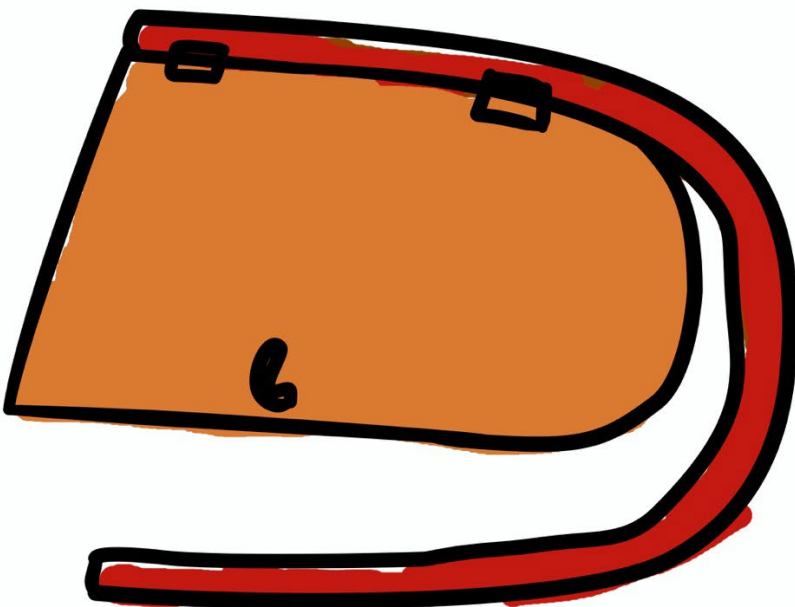

The door

A cartoon illustration of a brown satchel with a red strap and a black buckle, positioned vertically. The satchel is brown with a black outline and a small black handle. The red strap is attached to the top with two black buckles. The entire illustration is enclosed in a black rectangular border.

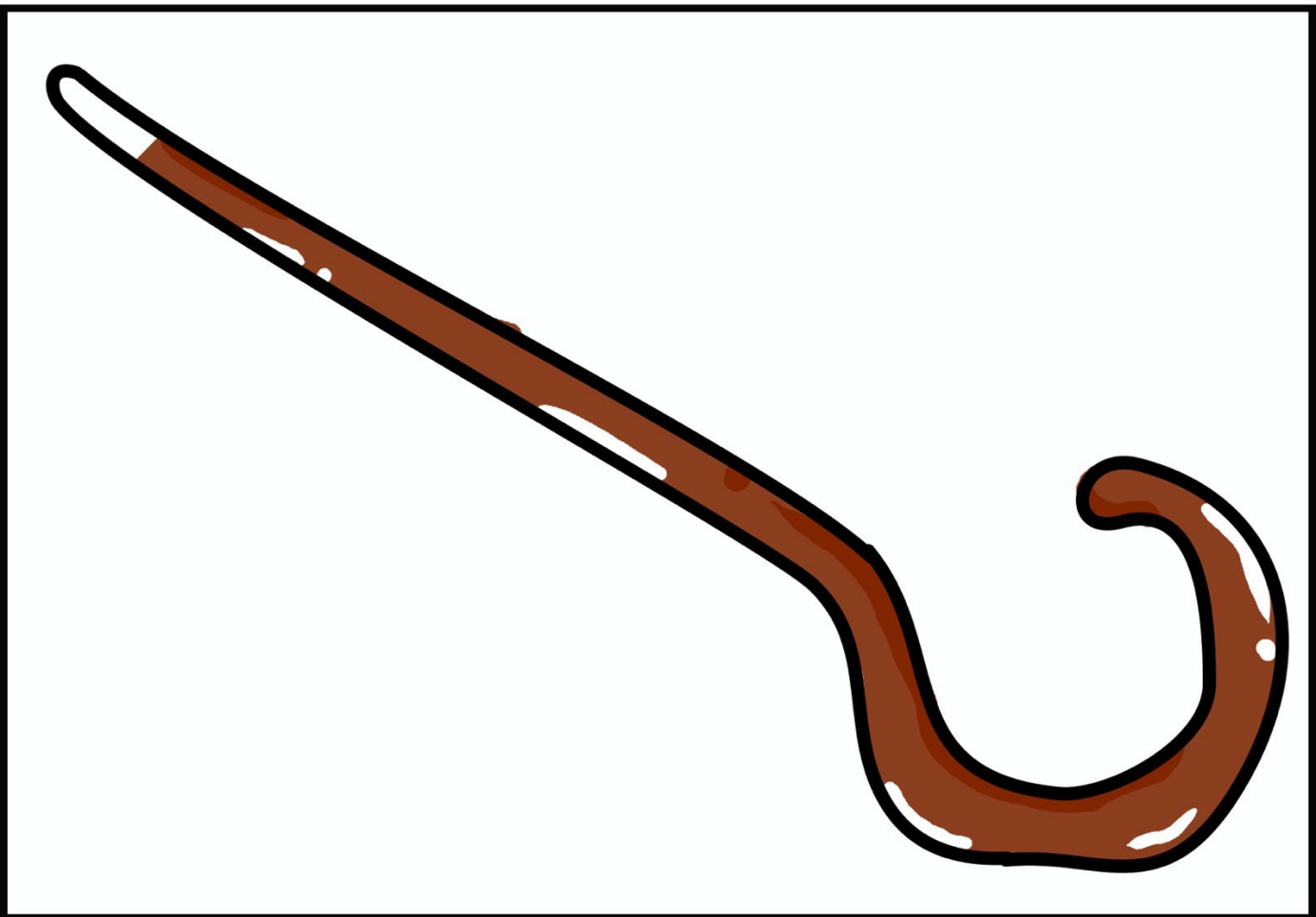

Jesus said
I AM

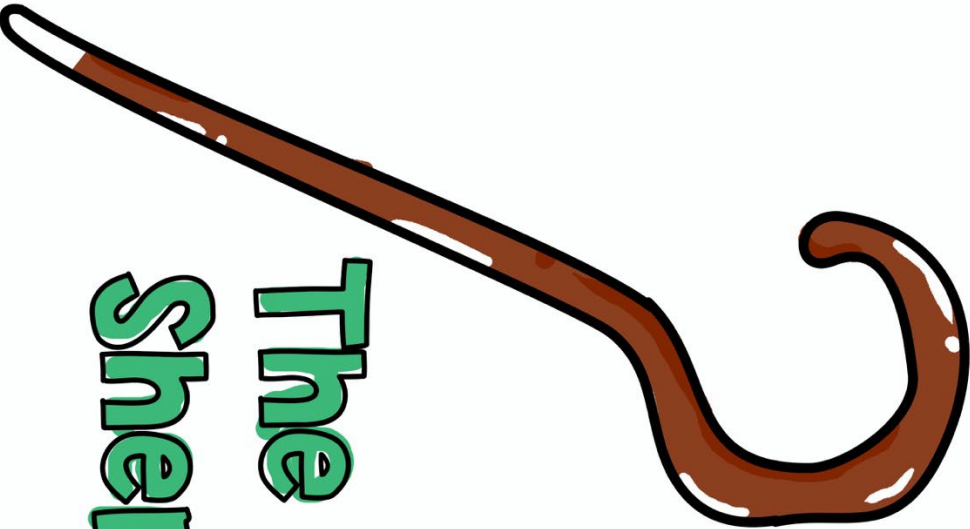

**The Good
Shepherd**

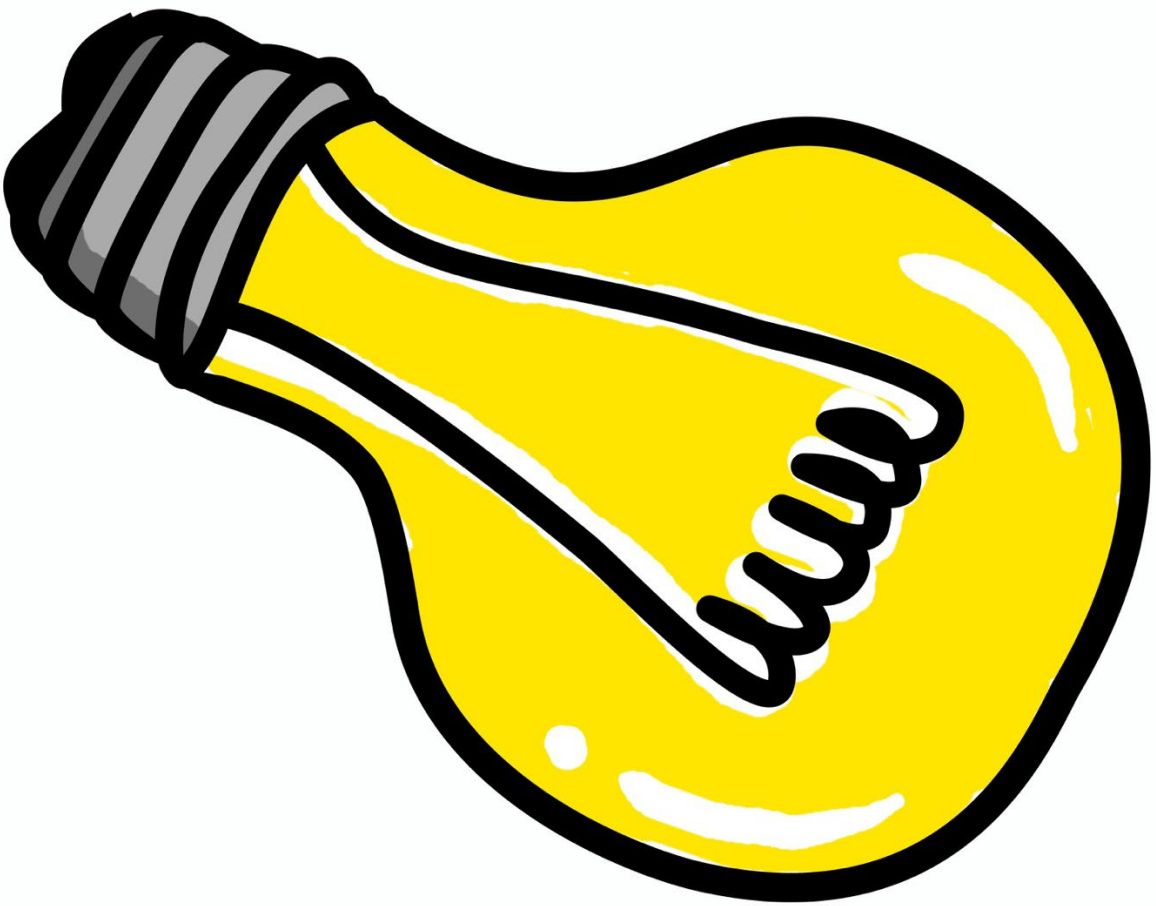

Jesus said

I AM

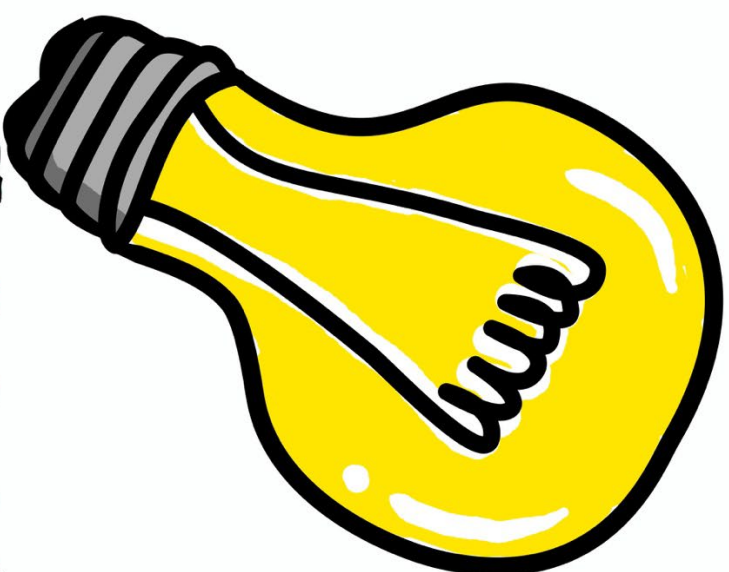

The light of
the world

Jesus said

I AM



The living
water



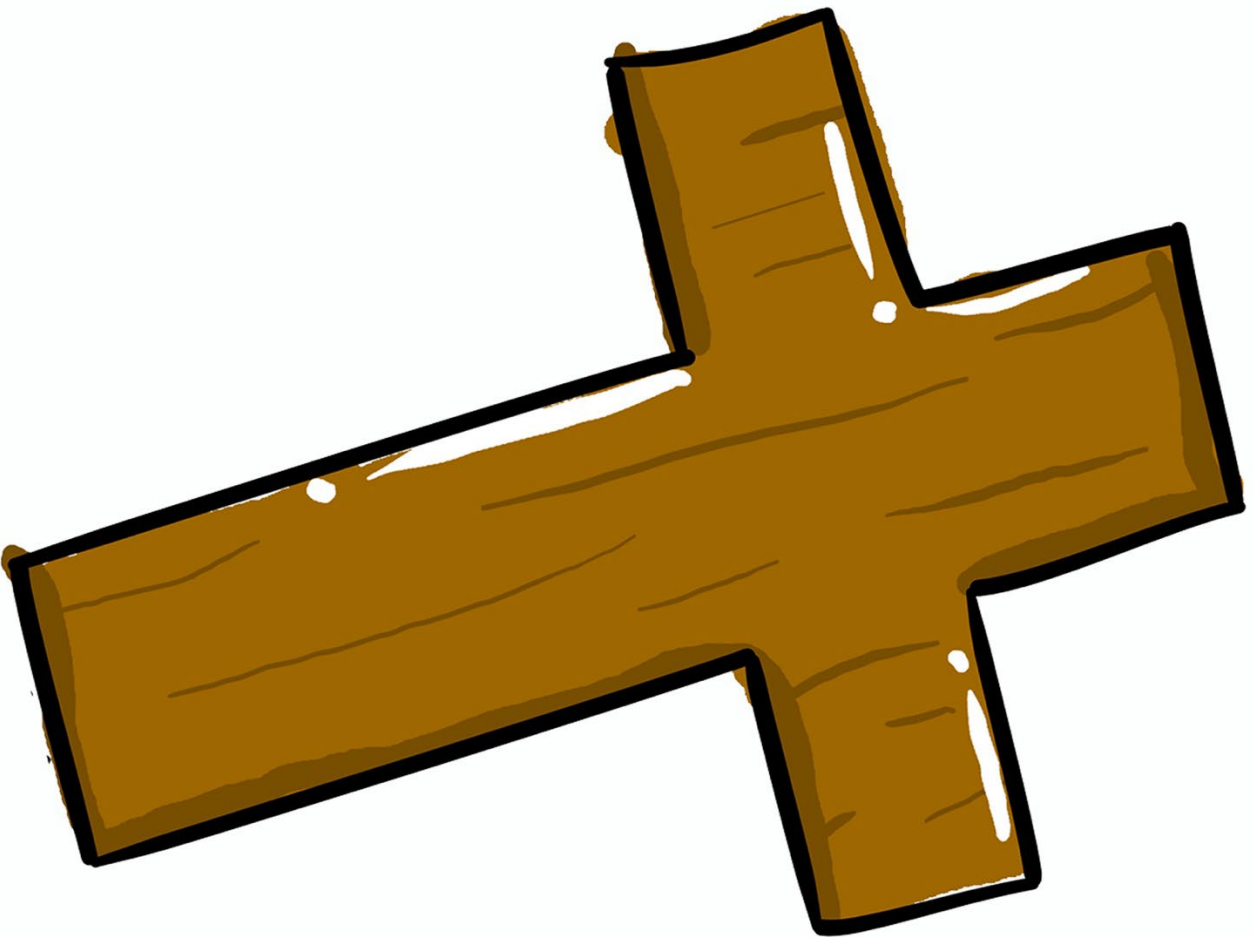

Jesus said

I AM

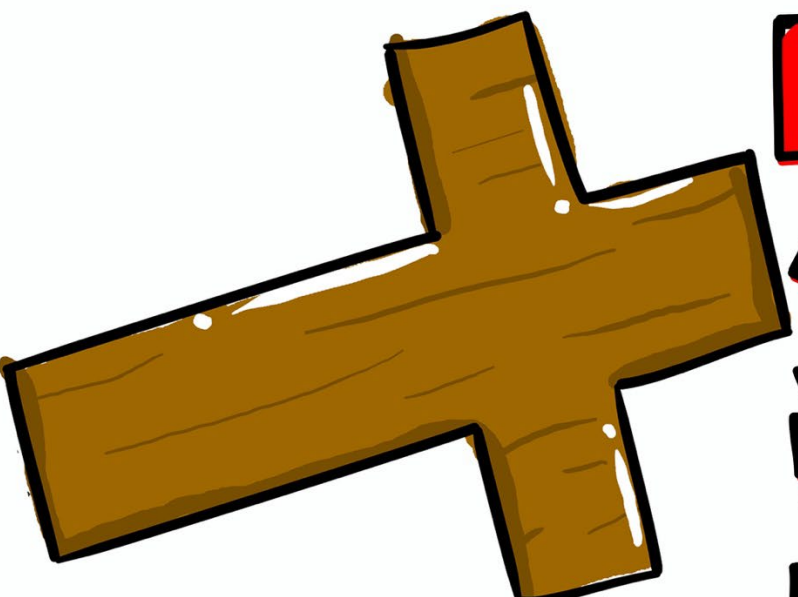

The Saviour

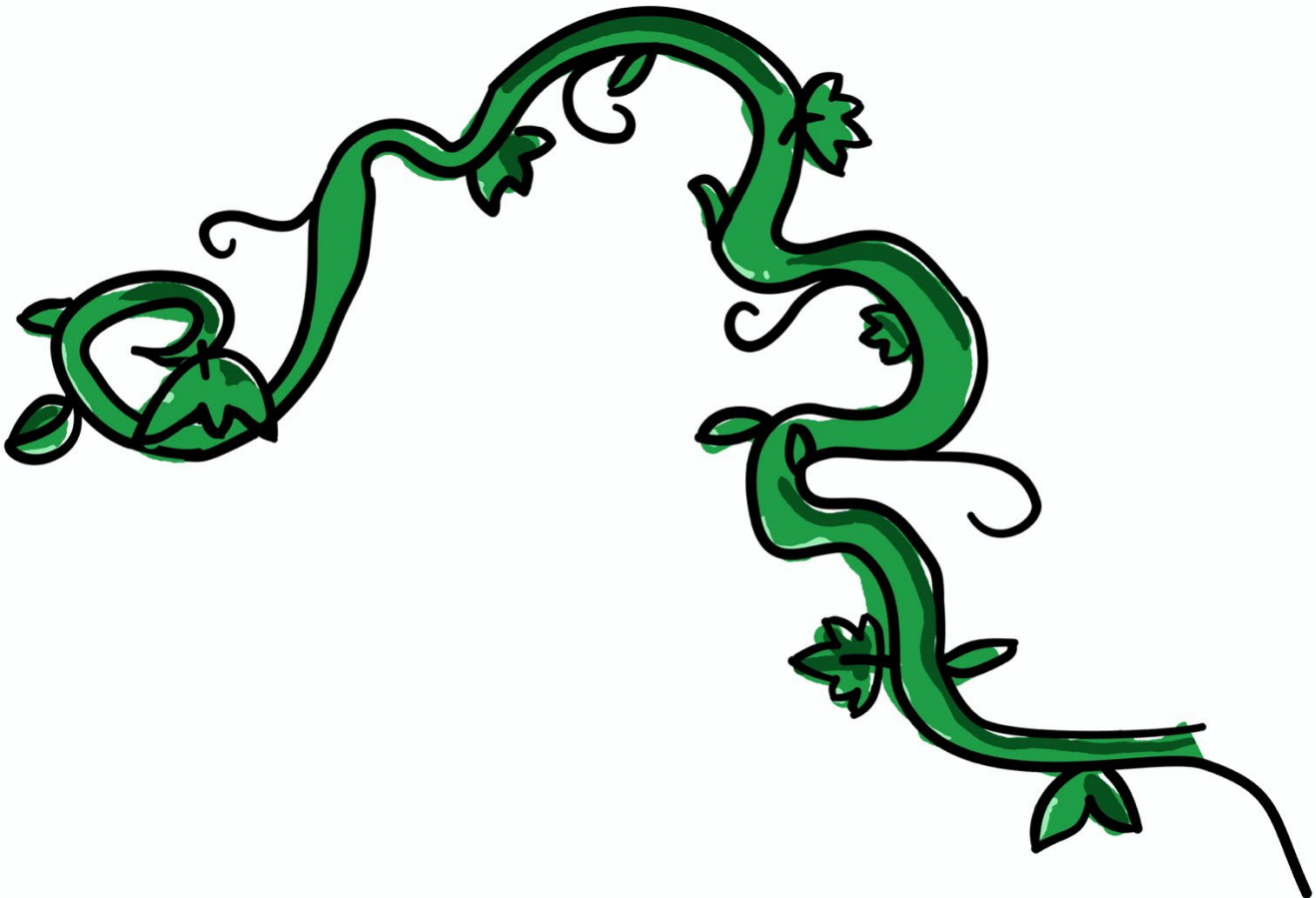

бипс зузәтү

МАТ

sniv snt



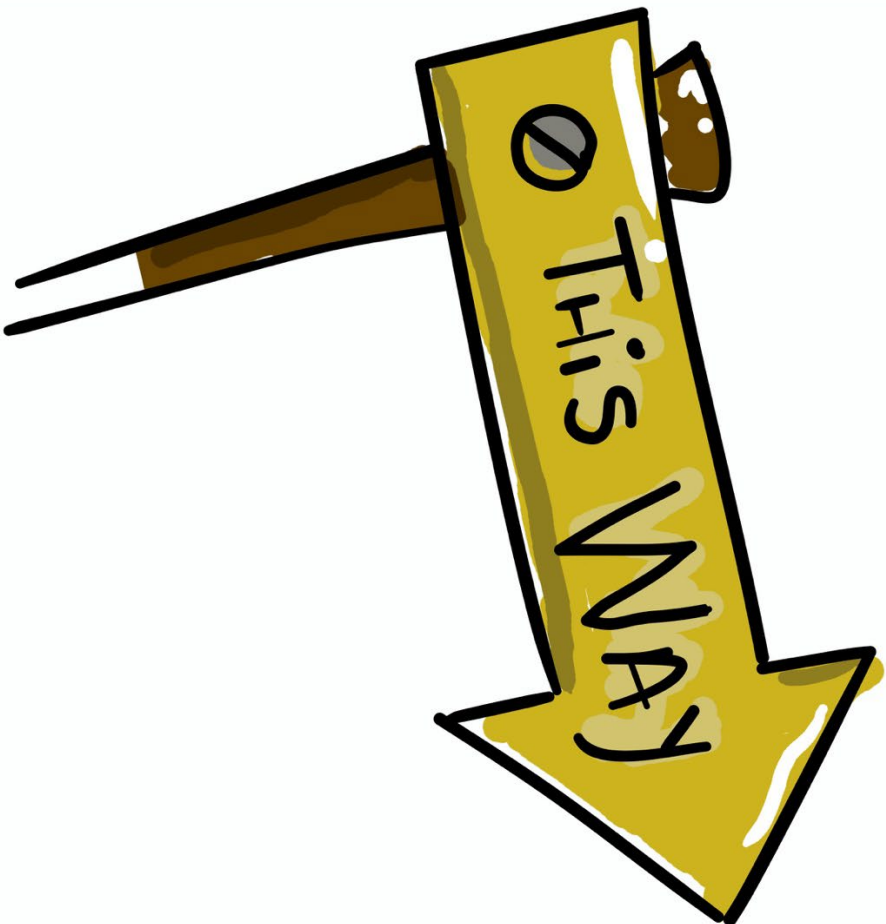

Jesus said

I AM

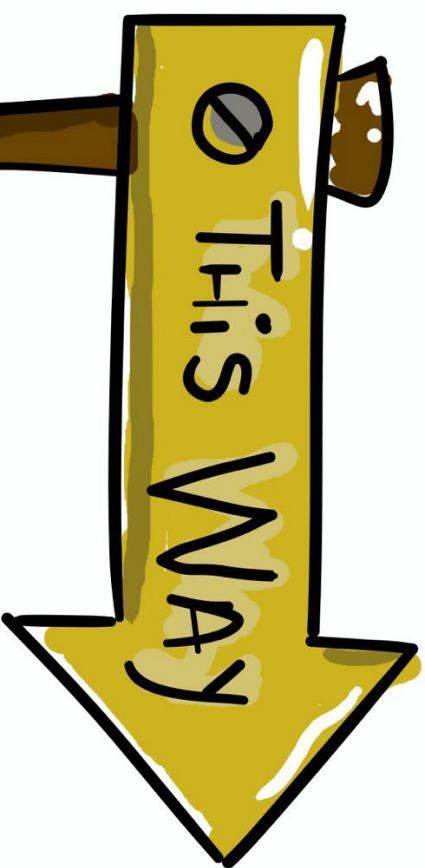

The way, truth
and life

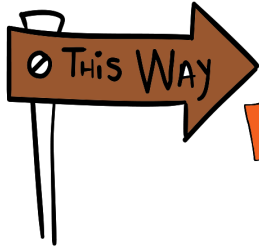

**JESUS IS THE
WAY THE TRUTH
AND THE LIFE**

**JESUS IS
THE DOOR**

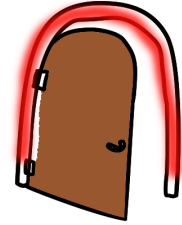

 **JESUS IS THE
LIGHT OF THE WORLD**

**JESUS IS THE
GOOD SHEPHERD**

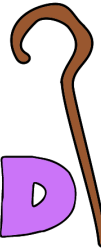

**JESUS IS THE BREAD
OF LIFE AND
THE LIVING WATER**



**JESUS IS
THE VINE**

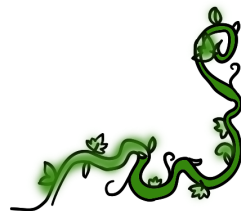

**JESUS IS
OUR SAVIOUR**

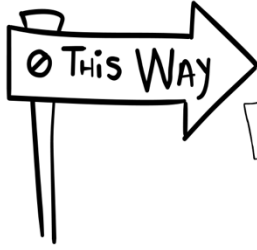

JESUS IS THE
WAY THE TRUTH
AND THE LIFE

JESUS IS
THE DOOR



JESUS IS THE
LIGHT OF THE WORLD

JESUS IS THE
GOOD SHEPHERD

JESUS IS THE BREAD
OF LIFE AND
THE LIVING WATER



JESUS IS
THE VINE



JESUS IS
OUR SAVIOUR

Craft option 2:



HOLD

Jesus

is

I AM

The Good Shepherd

Colour in the truths about the Good Shepherd and cross out the lies

Protects his sheep

Leaves his sheep to take a nap

Leads his sheep to green pastures

Leads his sheep to muddy water

Calls all sheep the same name

Finds and brings back the lost sheep

Never abandons his sheep

Loves his sheep

Cares for his sheep

Sacrifices his life for his sheep

Treats some sheep better than the rest

Read
John 10:1-18
Luke 15:3-7
Psalm 23

JESUS
is
our
Good
Shepherd

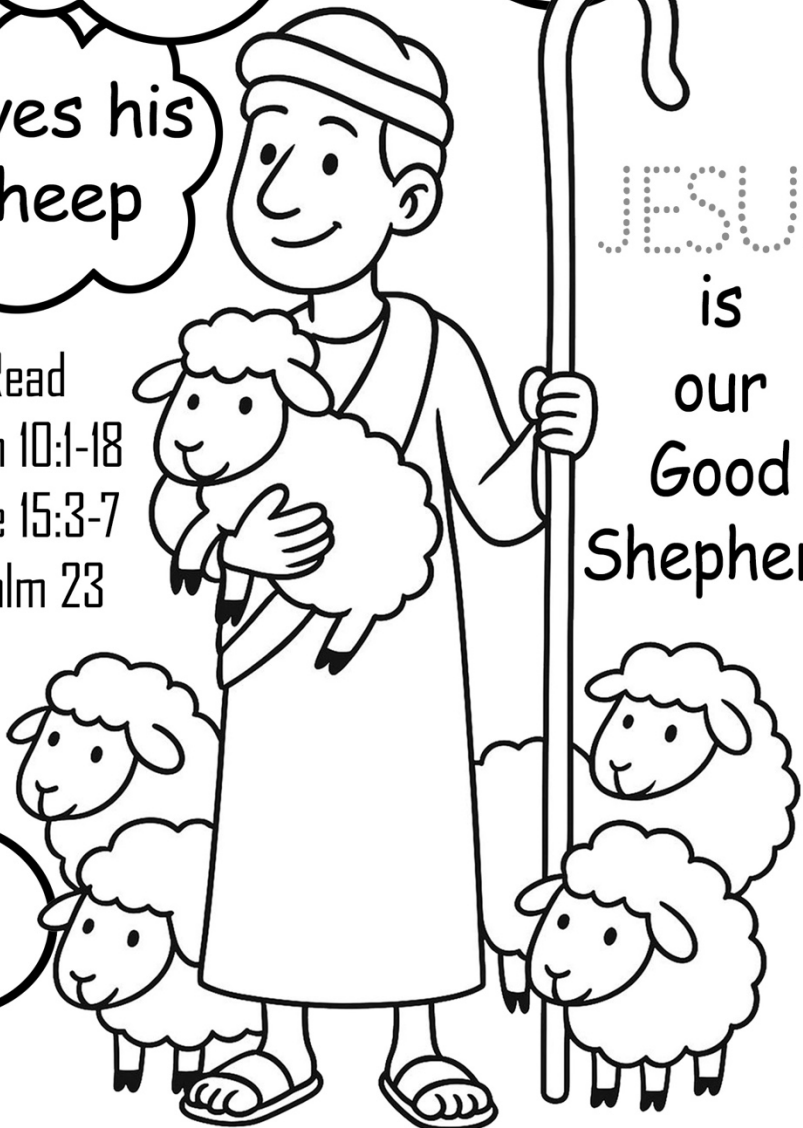

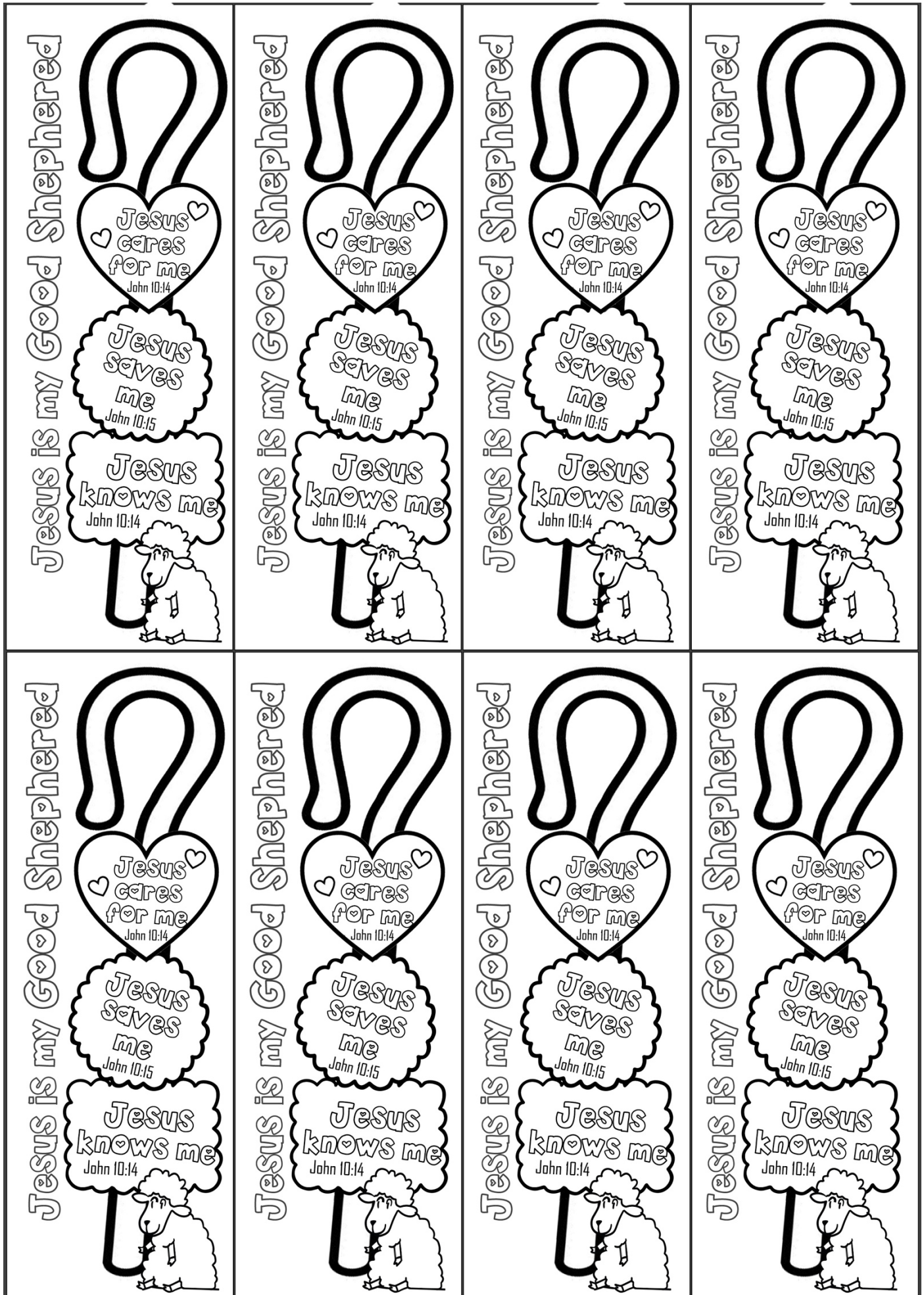

The Good Shepherd

Colour in the truths about the Good Shepherd and cross out the lies

Protects his sheep

Leaves his sheep to take a nap

Leads his sheep to green pastures

Leads his sheep to muddy water

Calls all sheep the same name

Finds and brings back the lost sheep

Never abandons his sheep

Loves his sheep

Cares for his sheep

Sacrifices his life for his sheep

Treats some sheep better than the rest

Read
John 10:1-18
Luke 15:3-7
Psalm 23

JESUS
is
our
Good
Shepherd



LESSON 7

Follow the maze to see if Jesus was like just any other king.

The maze consists of seven paths, each connecting a box on the left to a box on the right. The paths are colored as follows:

- Yellow path:** Connects "We would expect a king to be born in a beautiful palace" to "Jesus was born in a humble stable, surrounded by animals. (Luke 2:7)".
- Blue path:** Connects "We would expect a king to have many guards keeping us away" to "Jesus was rejected and hated by many people. (John 15:18)".
- Purple path:** Connects "We would expect a king to be served" to "Jesus fought sin and death alone and He won! (1 Corinthians 15:57)".
- Pink path:** Connects "We would expect a king to send others into battle" to "Jesus invites us, saying, 'Come close to Me.' (Matthew 11:28)".
- Teal path:** Connects "We would expect a king to be loved by many" to "Jesus chose to spend time with the sick, the poor, and those considered sinners. (Luke 5:27-32)".
- Orange path:** Connects "We would expect a king to be surrounded by important people" to "Jesus came to serve others and even gave His life for us. (Mark 10:45)".
- Light blue path:** Connects "We would expect a king to be born in a beautiful palace" to "Jesus came to serve others and even gave His life for us. (Mark 10:45)".

King Jesus is **GREATER** than any other king!

Craft option 1:

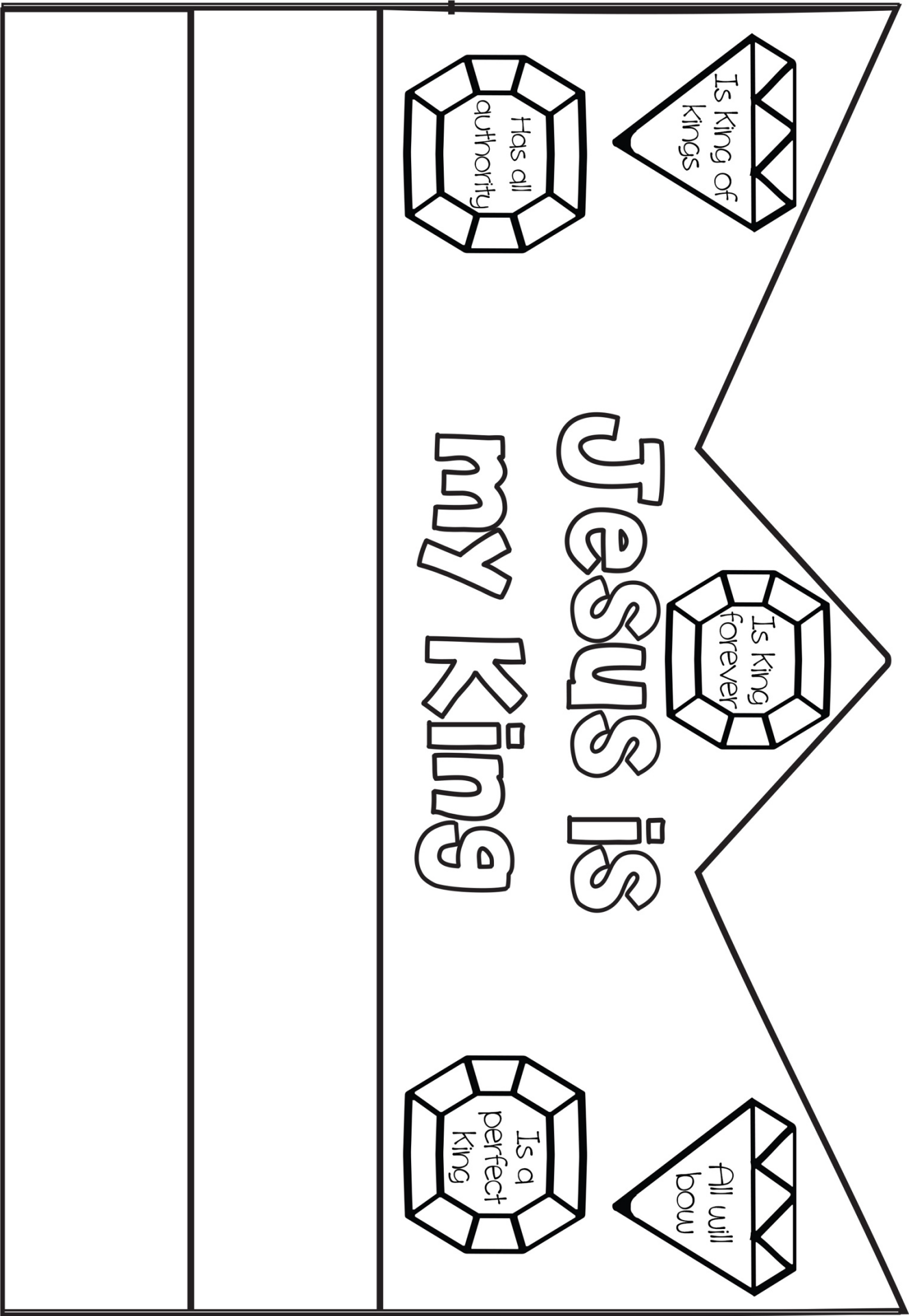

Craft option 2:

Follow the maze to see if Jesus was like just any other king.

We would expect a king to be born in a beautiful palace

We would expect a king to have many guards keeping us away

We would expect a king to be served

We would expect a king to send others into battle

We would expect a king to be loved by many

We would expect a king to be surrounded by important people

Jesus was born in a humble stable, surrounded by animals. (Luke 2:7)

Jesus was rejected and hated by many people. (John 15:18)

Jesus fought sin and death alone and He won! (1 Corinthians 15:57)

Jesus invites us, saying, "Come close to Me." (Matthew 11:28)

Jesus chose to spend time with the sick, the poor, and those considered sinners. (Luke 5:27-32)

Jesus came to serve others and even gave His life for us. (Mark 10:45)

King Jesus is **GREATER** than any other king!

Guess the miracle Jesus did...



Jesus calmed the storm
Mark 4:35-41

Guess the miracle Jesus did...

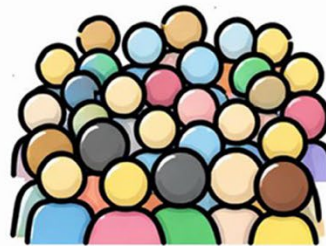

Jesus fed five thousand people
John 6:1-14

Guess the miracle Jesus did...



Jesus turned water to wine
Matthew 14:22-33

Guess the miracle Jesus did...



Jesus walked on water
Matthew 14:22-33

Guess the miracle Jesus did...



Jesus healed the paralyzed friend
Luke 5:18-25

Guess the miracle Jesus did...



Jesus raised Lazarus from the dead
John 11:38-44

Craft option 1:

Jesus did many miracles

Jesus healed the blind man
John 9:1-12

Jesus has all authority in Heaven and on Earth

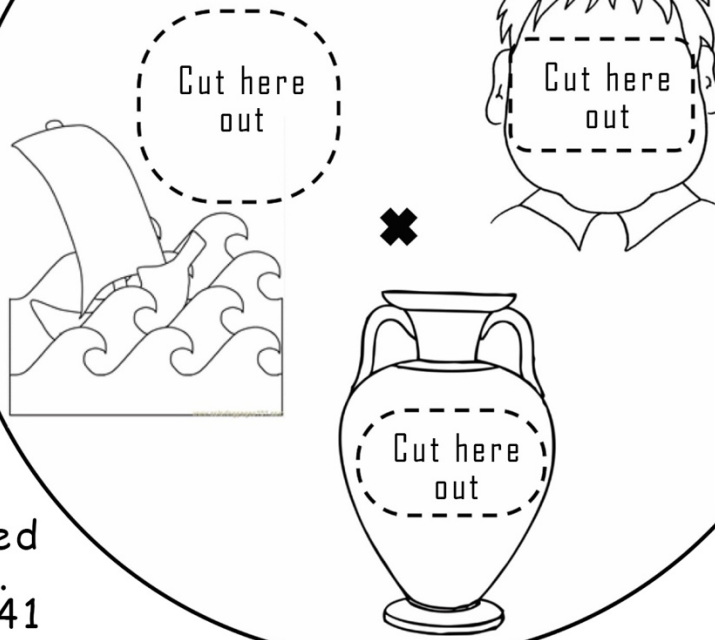



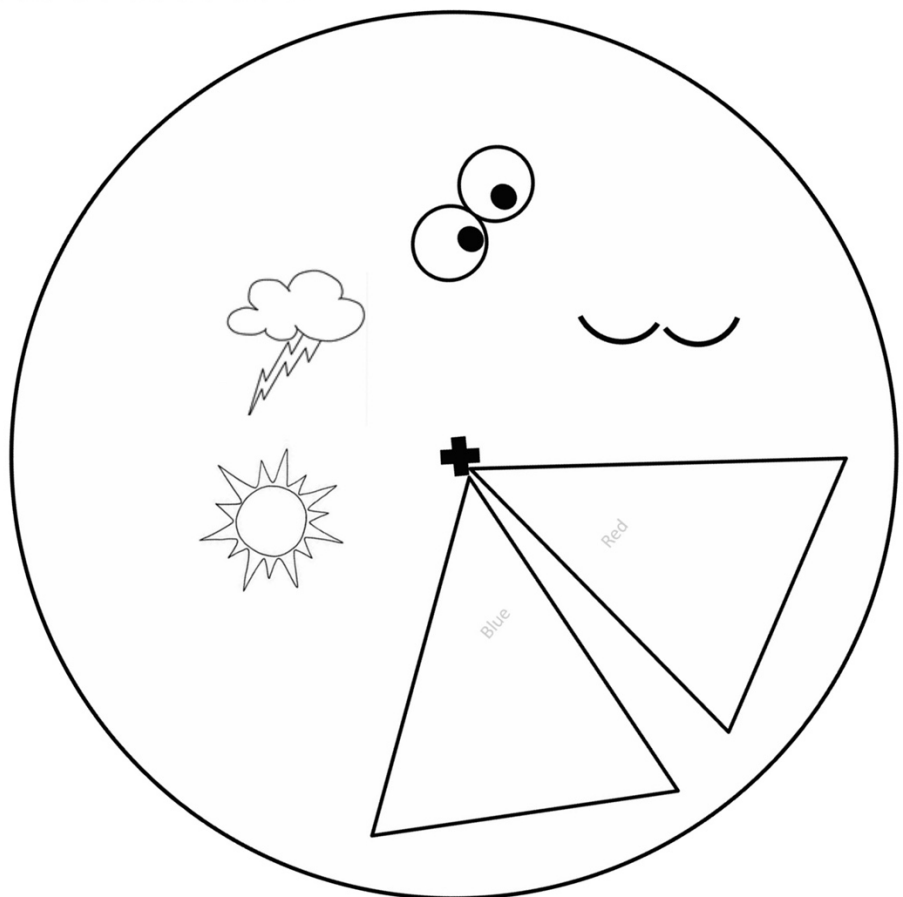

Jesus calmed the storm.
Mark 4:35-41

Jesus turned water to wine.
John 2:1-11

Cut this circle out and using a split pin join it behind the circle above.



Craft option 2:

<p>AUTHORITY</p>	<p>Did Jesus bring Lazarus back to life? John 11: 38-44</p> <p>Yes, Jesus has all authority over life and death</p>	<p>Did Jesus turn water into wine? John 2:1-11</p> <p>Yes, Jesus has all authority to create instantly</p>	<p>ALL</p>
<p>Did Jesus feed 5000 from a small lunch? John 6:1-14</p> <p>Yes, Jesus has all authority to create instantly</p>			<p>Did Jesus walk on water? Matthew 14:22-33</p> <p>Yes, Jesus has all authority over creation</p>
<p>Did Jesus heal the lame friend? Luke 5:18-25</p> <p>Yes, Jesus has all authority over sickness</p>			<p>Did Jesus heal the lady who was sick for 12 years? Luke 8:43-48</p> <p>Yes, Jesus has all authority over sickness</p>
<p>JESUS</p>	<p>Did Jesus calm the storm by speaking? Mark 4: 35-41</p> <p>Yes, Jesus has all authority over nature</p>	<p>Did Jesus die and come back to life? Mark 16:5</p> <p>Yes, Jesus has all authority over life and death</p>	<p>HAS</p>

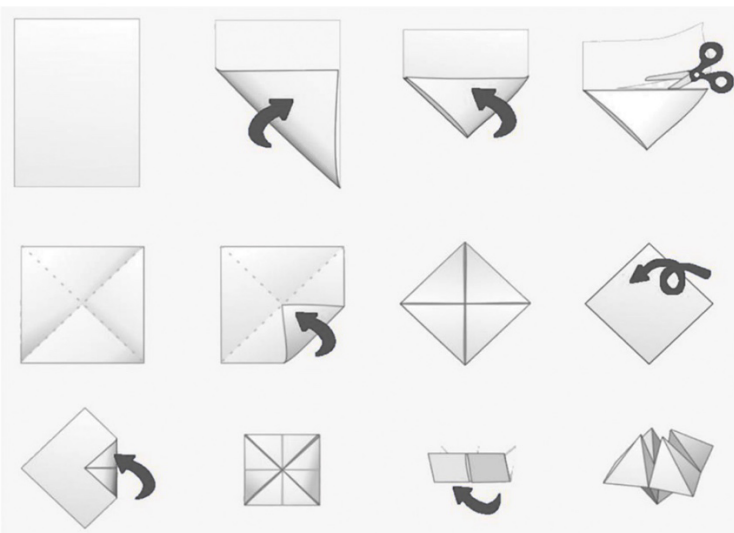

How to use the "quack quack" craft:

1. Start by choosing one of the four outside options. So, if you choose "Jesus" you have to open and close your fingers while spelling out "J-E-S-U-S"
2. You could also say the verse and open and close your fingers on every word. "All authority has been given to Jesus in Heaven and on Earth."
3. Next you choose one of the inside questions to answer and open the flap to reveal the answer.

LESSON 9



Craft option 1:

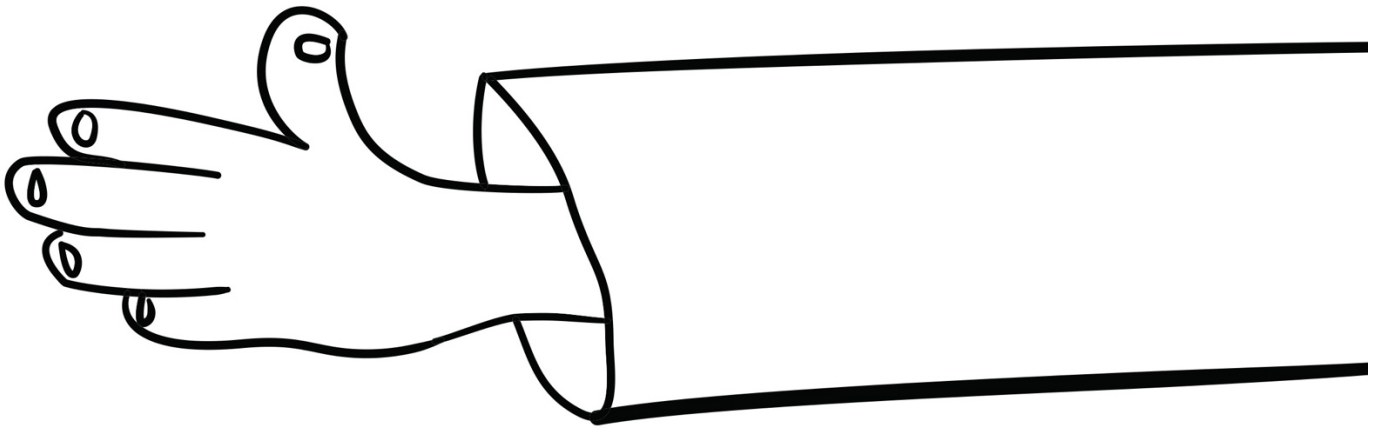

Cut out the arm and stick a tissue under the hand. Use a split pin to join it to the picture below.
Swivel from side to side to wash the feet.

Jesus was a humble servant.
He washed the disciples' feet
and He washes away our sin!

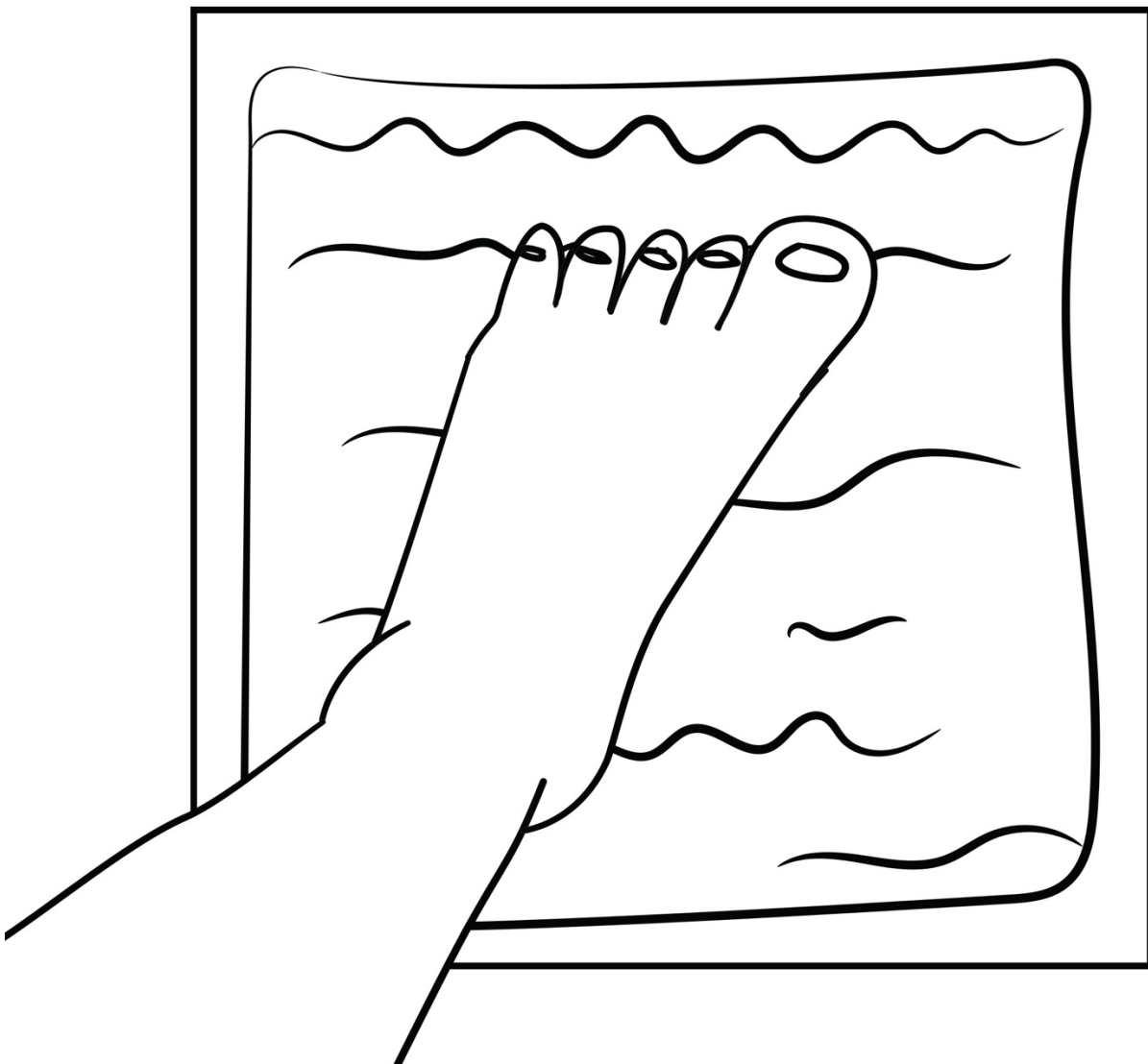

Craft option 2:

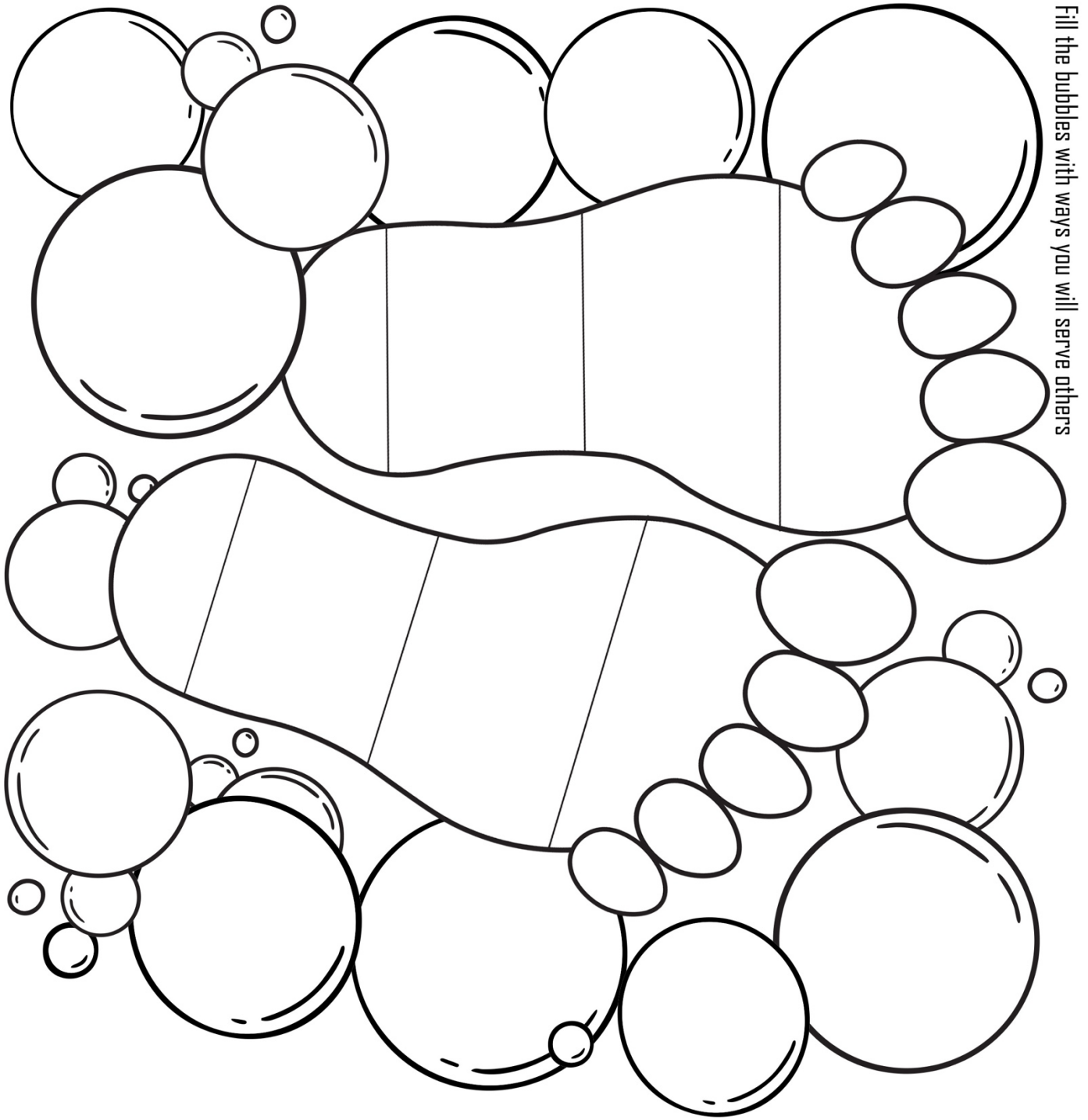

Fill the bubbles with ways you will serve others

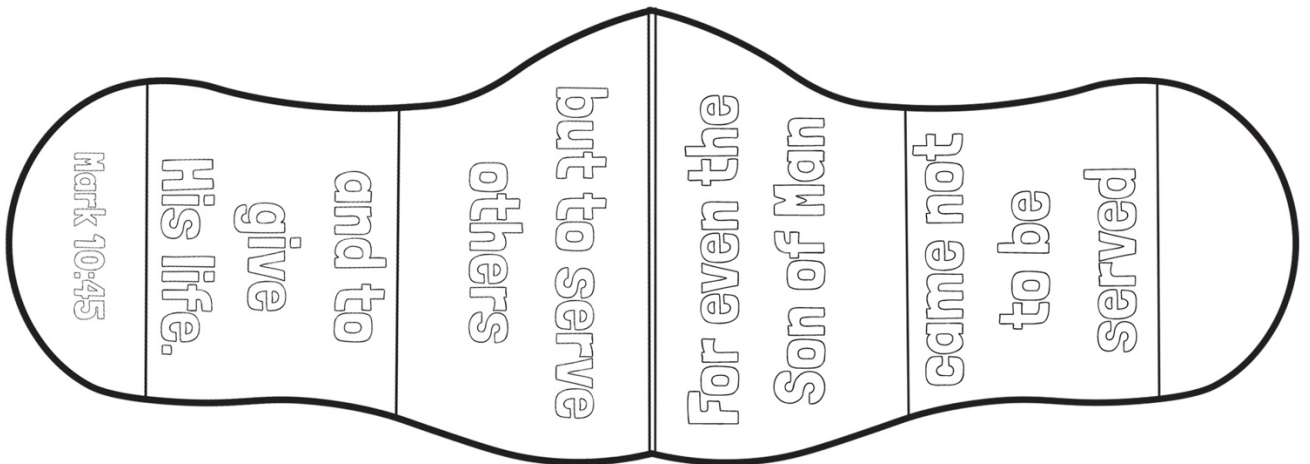

Cut and stick the verse in order.

Mark 10:45

His life.

give

and to

others

but to serve

For even the

Son of Man

came not

to be

served

4

GOD



The World



that He



gave

His only



SON

THAT



WHOEVER

BELIEVES IN HIM

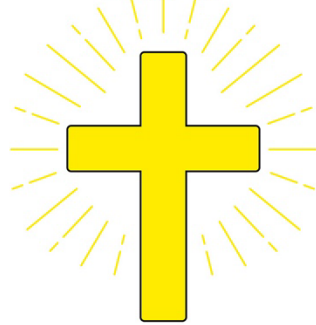

SHOULD

NOT

PERISH

but have



eternal

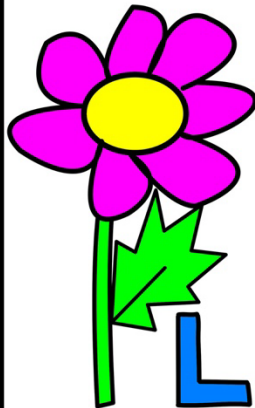

Life

John

3:16

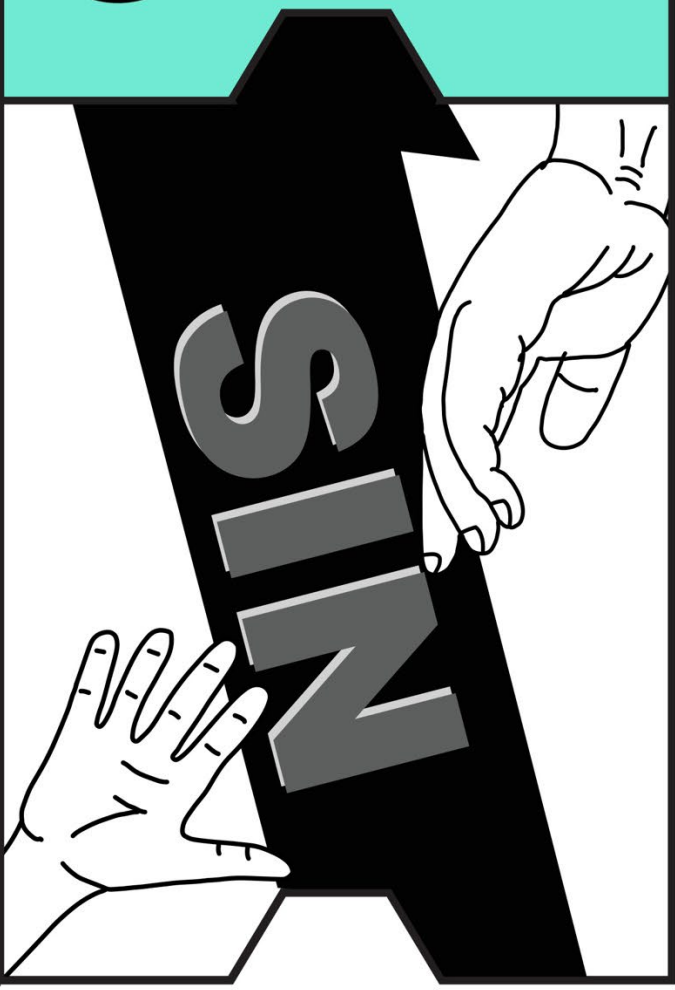
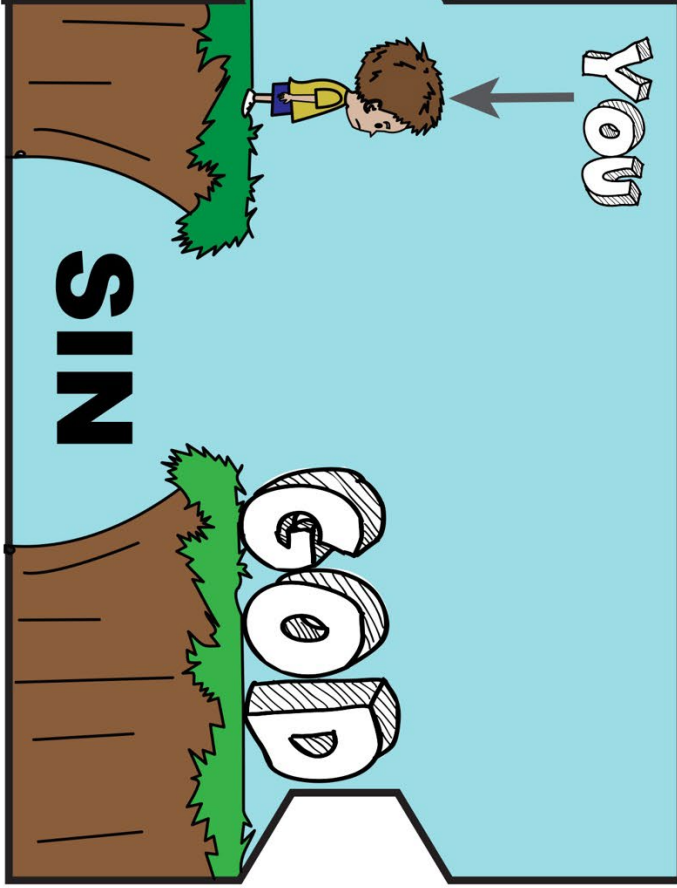
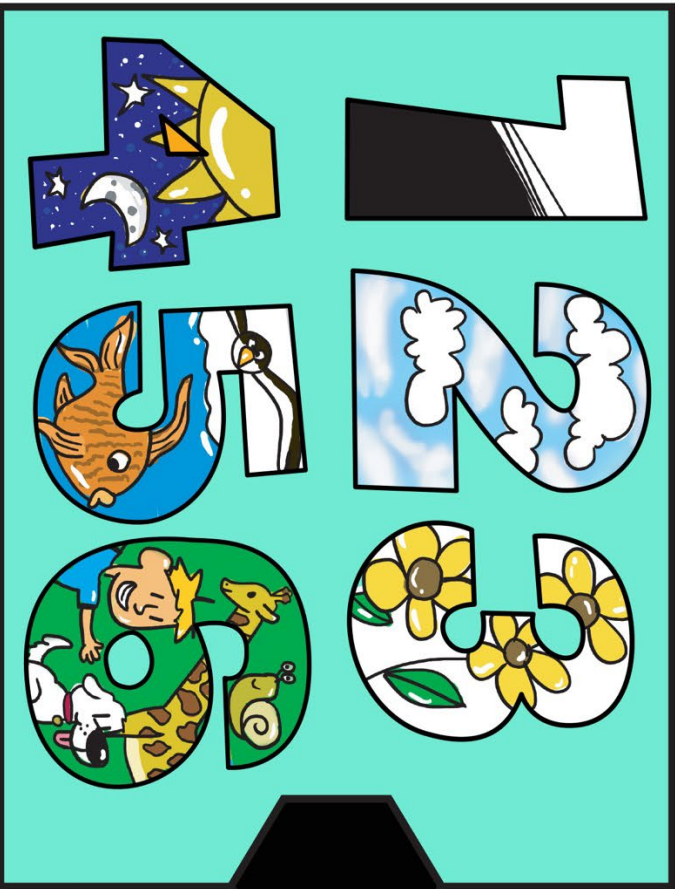
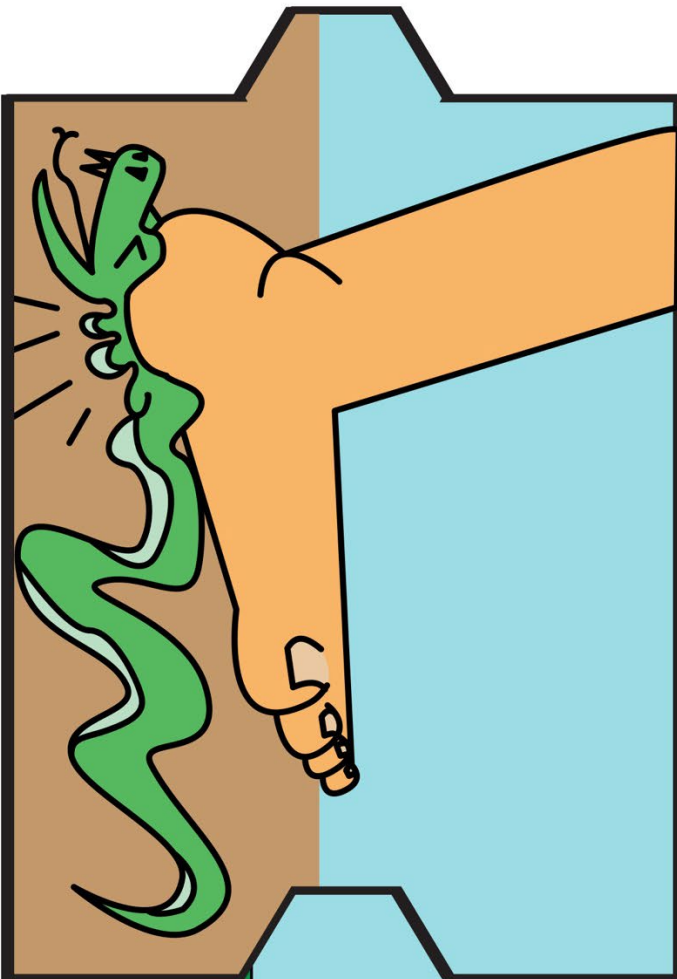

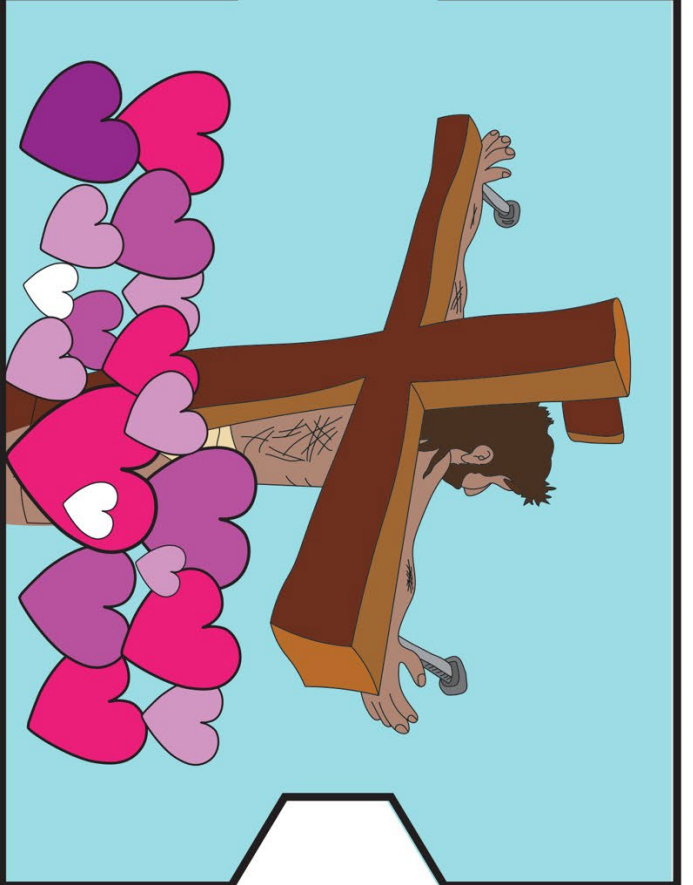
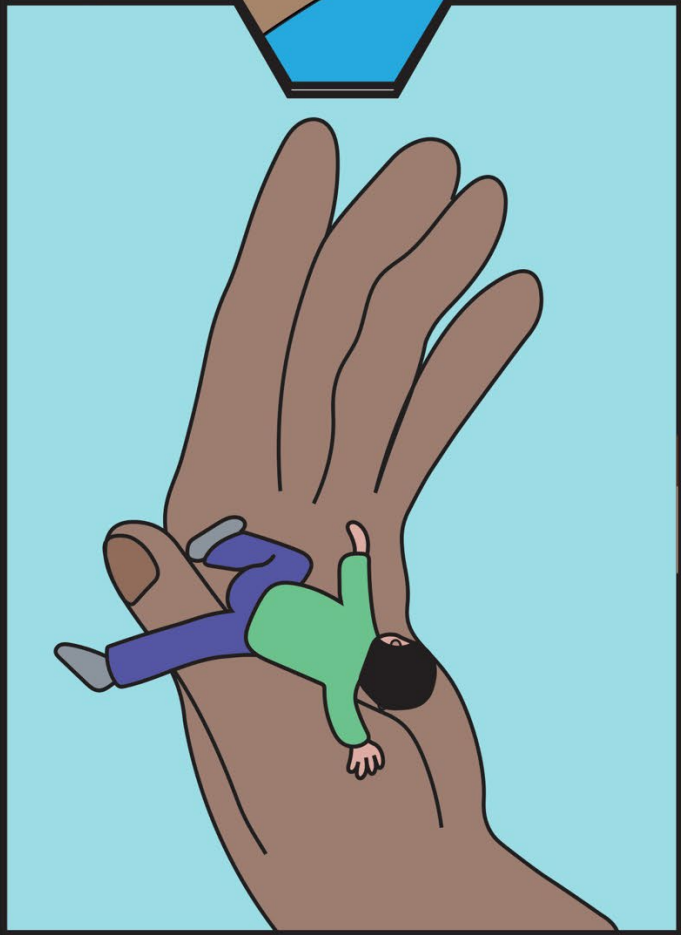
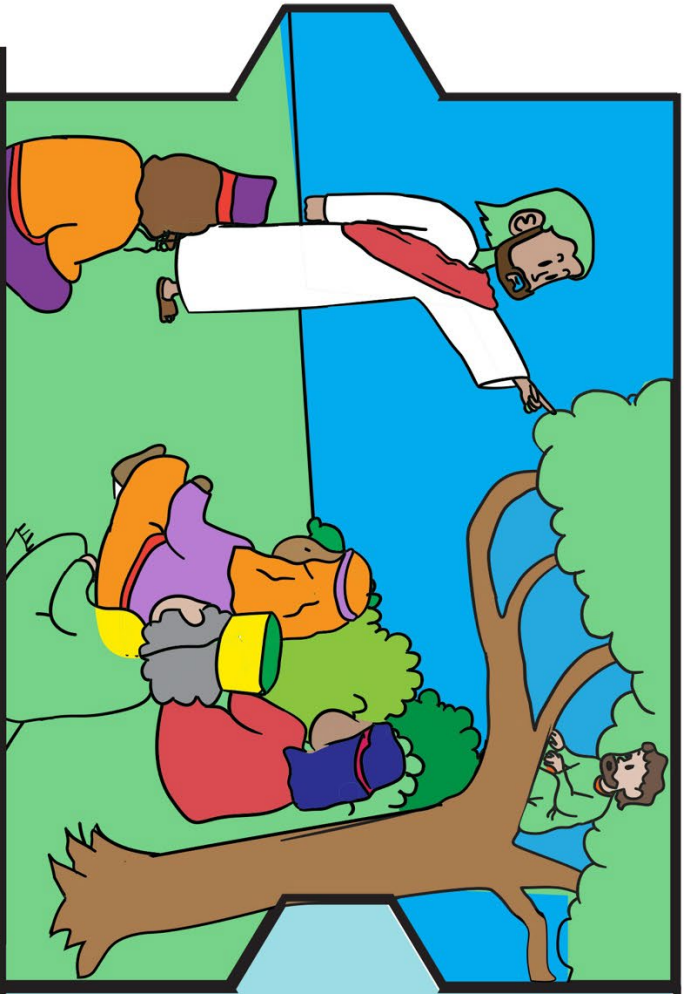
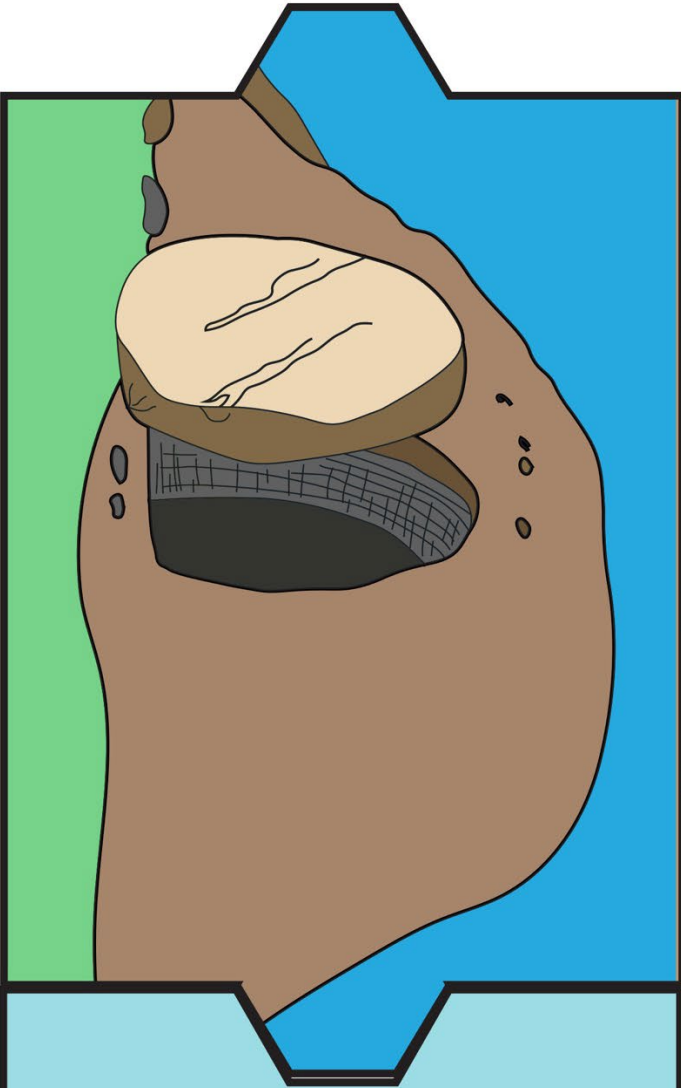

Craft option 1:

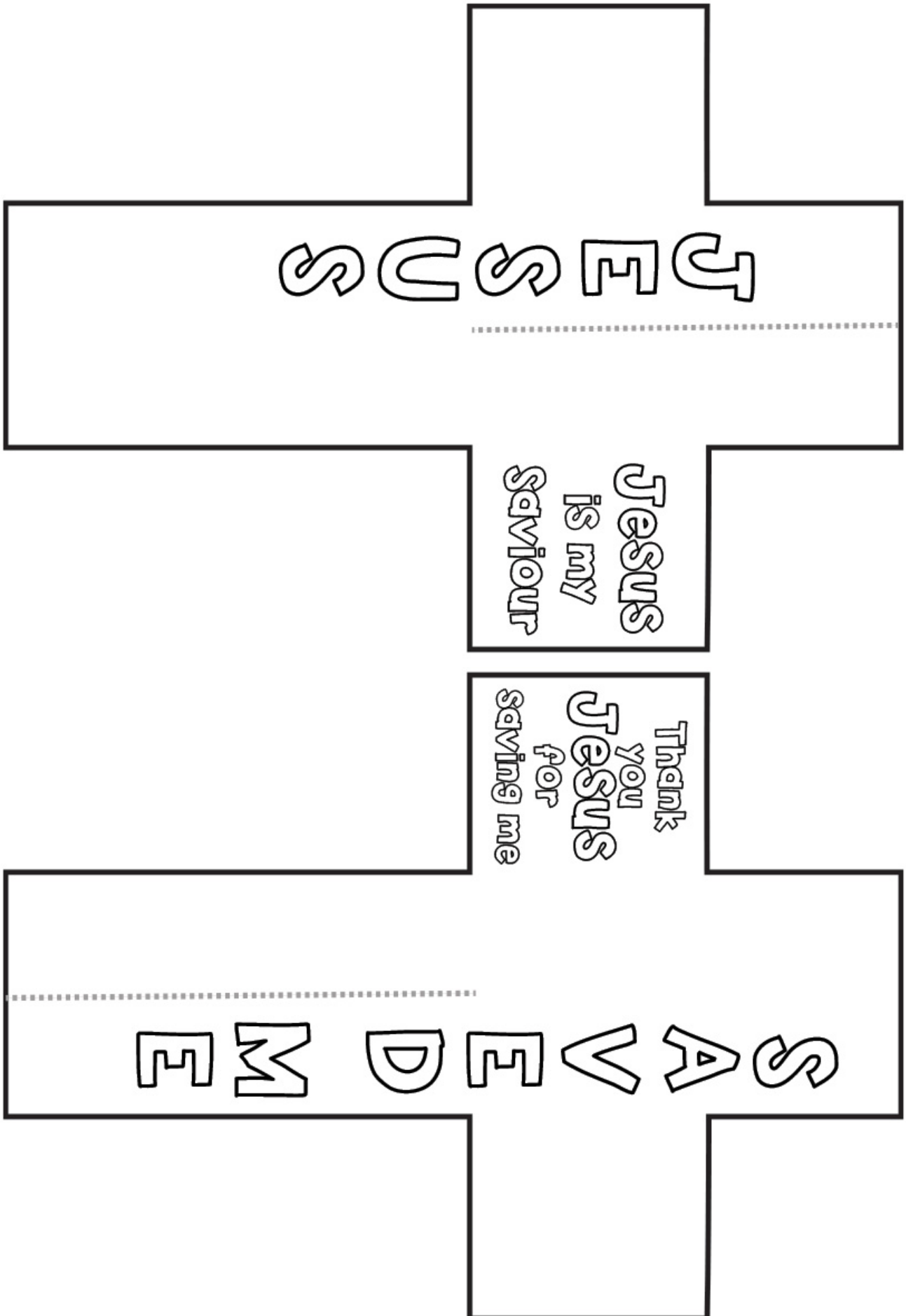

1 God made everything perfectly

2 Jesus is our Saviour

3 Our sin separated us from God

4 Jesus took our punishment

5 God promised to send a Saviour who would destroy evil and sin once and for all

6 Jesus came alive and is still alive today!

7 We cannot save ourselves from sin and separation from God

8 We can be with God forever. Jesus is our Saviour!

9 Thank you Jesus!

1 God made everything perfectly

2 Jesus is our Saviour

3 Our sin separated us from God

4 Jesus took our punishment

5 God promised to send a Saviour who would destroy evil and sin once and for all

6 Jesus came alive and is still alive today!

7 We cannot save ourselves from sin and separation from God

8 We can be with God forever. Jesus is our Saviour!

9 Thank you Jesus!

1 God made everything perfectly

2 Jesus is our Saviour

3 Our sin separated us from God

4 Jesus took our punishment

5 God promised to send a Saviour who would destroy evil and sin once and for all

6 Jesus came alive and is still alive today!

7 We cannot save ourselves from sin and separation from God

8 We can be with God forever. Jesus is our Saviour!

9 Thank you Jesus!

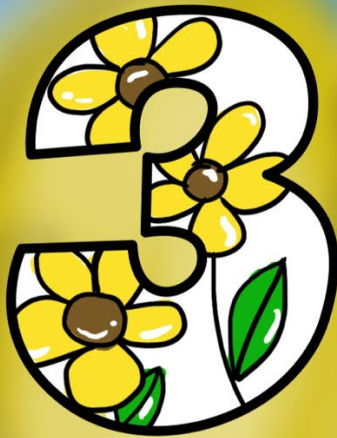

**JESUS OUR
CREATOR IS FAR
ABOVE THE REST,**



**JESUS LAID ASIDE
HIS CROWN TO SERVE
YOU AND ME**



**JESUS IS OUR
TEACHER, WHO SHOWS
US GOD'S PLAN.**

The background is a bright yellow gradient. It is filled with numerous colorful speech bubbles and checkmarks. The speech bubbles come in various shapes and colors, including purple, green, pink, blue, brown, and teal. Each bubble contains a black checkmark. The checkmarks are scattered throughout the page, some inside the bubbles and some outside. The overall theme is one of approval and fulfillment.

Promised One

**JESUS, THE
PROMISED ONE,
PASSED EVERY TEST.**



**JESUS IS OUR SAVIOUR,
THE LIFE, THE TRUTH,
THE WAY**



**JESUS IS GOD'S SON,
FULLY GOD
AND FULLY MAN,**



**JESUS is THE
KING OF KINGS
FOR ETERNITY,**









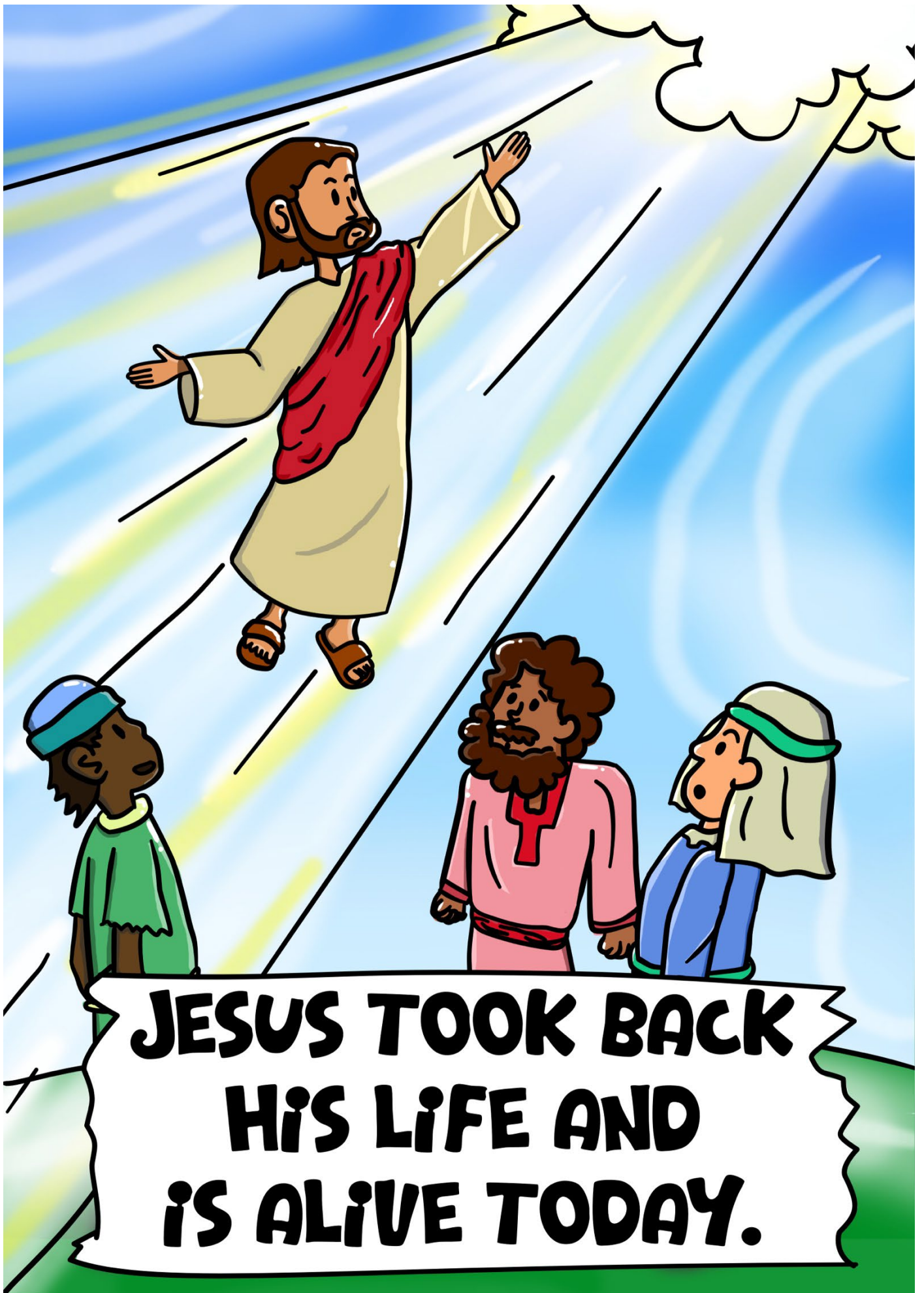

**JESUS is "i AM", HE
IS ALL THAT WE**

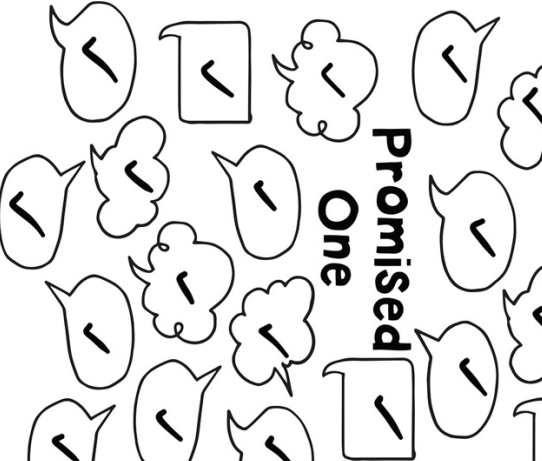
I AM

**NEED, JESUS is OUR
SHEPHERD, i'll FOLLOW
WHERE HE LEADS.**

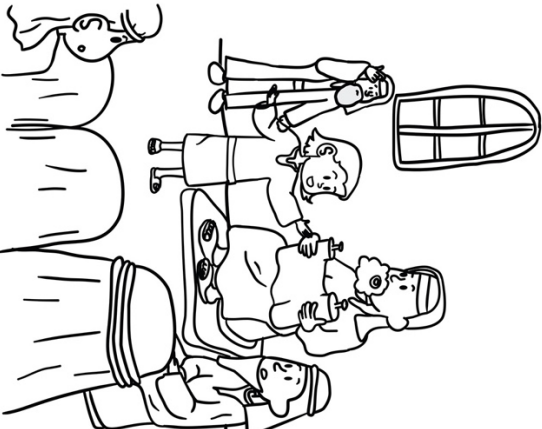
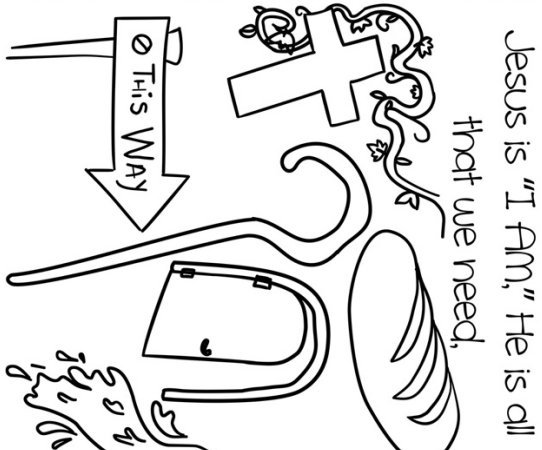
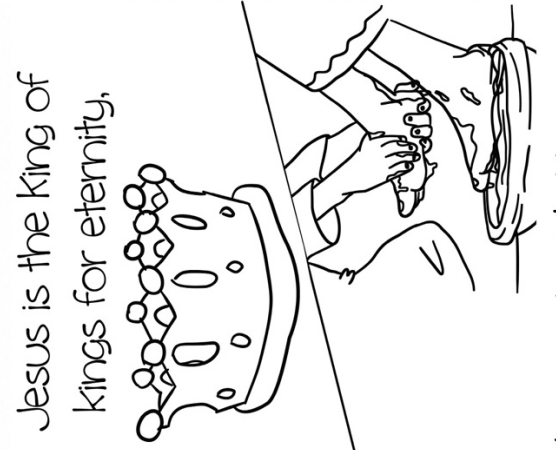
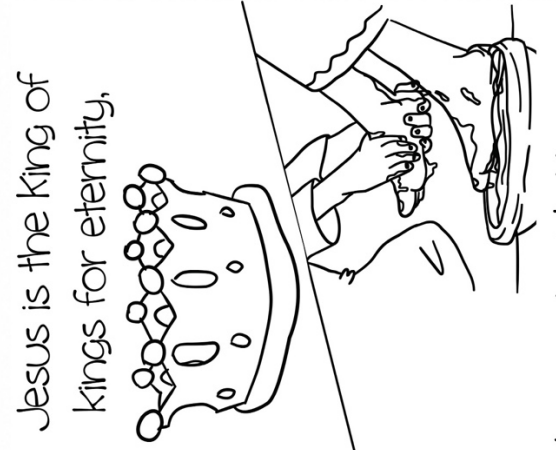

**JESUS TOOK BACK
HIS LIFE AND
IS ALIVE TODAY.**

 <p>Promised One</p> <p>Jesus, the Promised One, passed every test.</p>	 <p>Jesus is God's Son, fully God and fully man.</p>	 <p>Jesus took back His life and is still alive today</p>	 <p>Jesus is our Saviour, the life the truth, the way</p>
 <p>Jesus is our Teacher, who shows us God's plan.</p>	 <p>Jesus is "I AM," He is all that we need.</p> <p>Jesus is our Shepherd, I'll follow where He leads.</p>	 <p>Jesus is the king of kings for eternity,</p>	 <p>Jesus put aside His crown to serve you and me</p>
 <p>Jesus is God's Son, fully God and fully man.</p>	 <p>Jesus took back His life and is still alive today</p>	 <p>Jesus is our Saviour, the life the truth, the way</p>	 <p>Jesus put aside His crown to serve you and me</p>

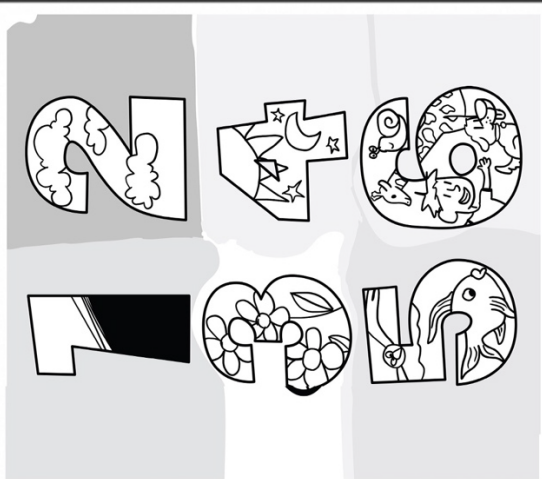

Jesus our Creator is far above the rest,

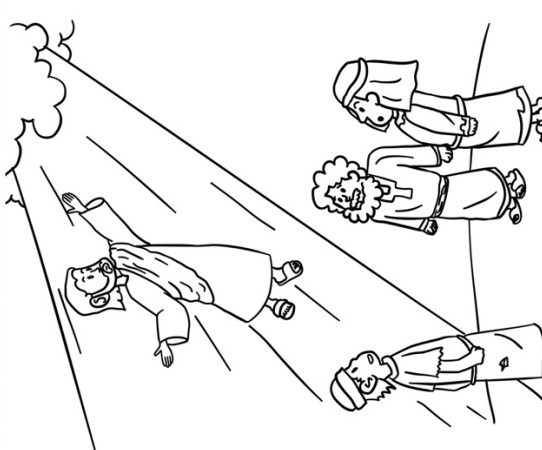

Jesus took back His life and is still alive today

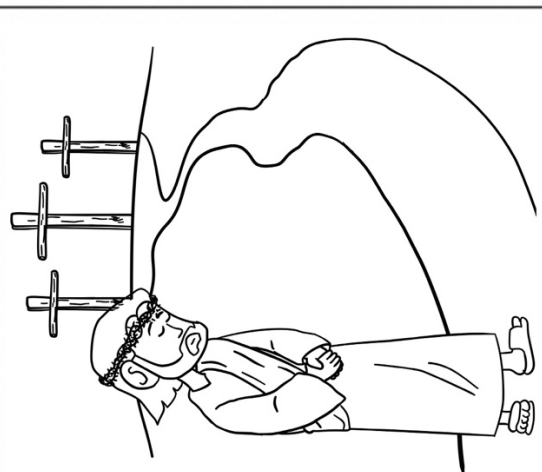

Jesus is our Saviour, the life the truth, the way

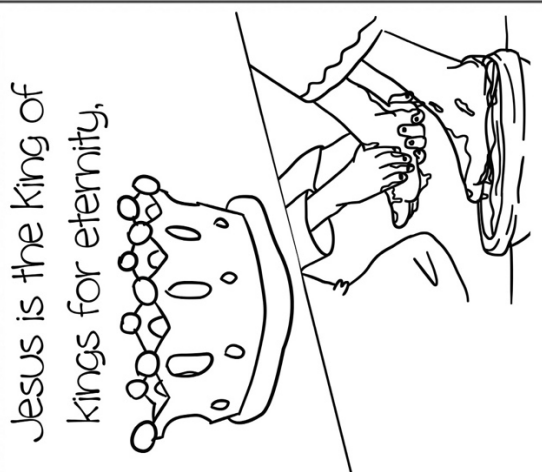

Jesus put aside His crown to serve you and me

Craft option 2:

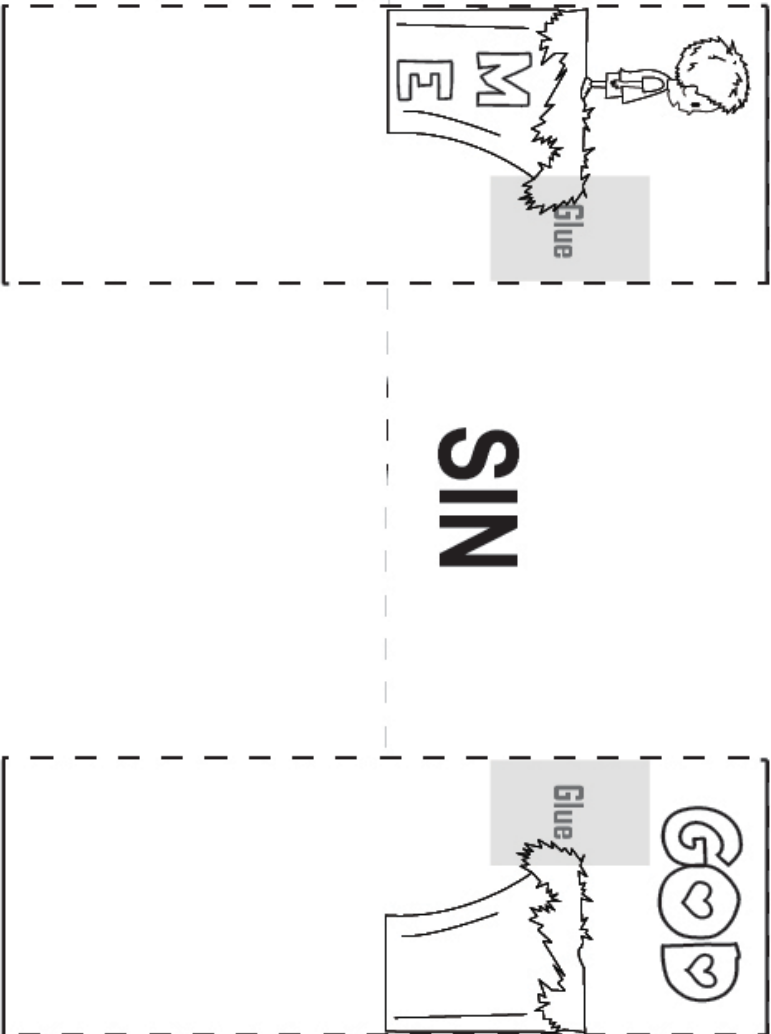
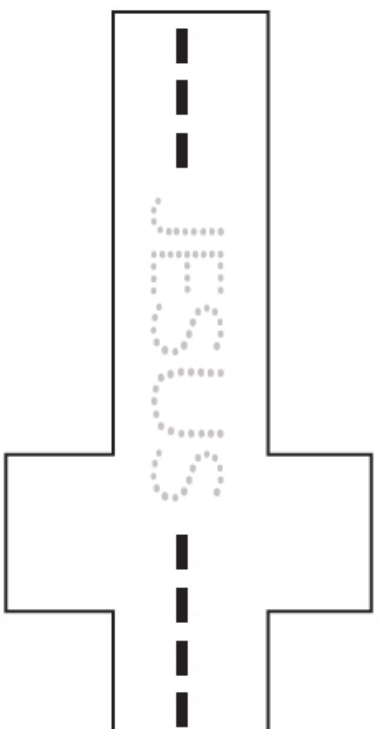

Jesus told him, "I am the way, the truth, and the life.
No one can come to the Father except through Me."
John 14:6

- 1) Cut out the cross with JESUS on it and set it aside.
- 2) Fold the rest of the page in half horizontally along the central dotted line.
- 3) Cut along the other four dotted lines.
- 4) Unfold the page to 90 degrees so that the top of the page stands up. Push the cliff parts of to picture forward and invert the folds so that they stand out.
- 5) Put a little glue on the marked grey spots and stick the cross across the space between "me" and "God".